



Open Frame Monitor- 15", 17", 19"

Doc. User Guide Rev. 1.1

Doc. ID: 1066-4064

This page has been intentionally left blank

▶ OPEN FRAME MONITOR- 15", 17", 19"

Disclaimer

Kontron would like to point out that the information contained in this user guide may be subject to alteration, particularly as a result of the constant upgrading of Kontron products. This document does not entail any guarantee on the part of Kontron with respect to technical processes described in the user guide or any product characteristics set out in the user guide. Kontron assumes no responsibility or liability for the use of the described product(s), conveys no license or title under any patent, copyright or mask work rights to these products and makes no representations or warranties that these products are free from patent, copyright or mask work right infringement unless otherwise specified. Applications that are described in this user guide are for illustration purposes only. Kontron makes no representation or warranty that such application will be suitable for the specified use without further testing or modification. Kontron expressly informs the user that this user guide only contains a general description of processes and instructions which may not be applicable in every individual case. In cases of doubt, please contact Kontron.

This user guide is protected by copyright. All rights are reserved by Kontron. No part of this document may be reproduced, transmitted, transcribed, stored in a retrieval system, or translated into any language or computer language, in any form or by any means (electronic, mechanical, photocopying, recording, or otherwise), without the express written permission of Kontron. Kontron points out that the information contained in this user guide is constantly being updated in line with the technical alterations and improvements made by Kontron to the products and thus this user guide only reflects the technical status of the products by Kontron at the time of publishing.

Brand and product names are trademarks or registered trademarks of their respective owners.

©2020 by Kontron S&T AG

Kontron S&T AG

Lise-Meitner-Str. 3-5
86156 Augsburg
Germany
www.kontron.com

Intended Use

THIS DEVICE AND ASSOCIATED SOFTWARE ARE NOT DESIGNED, MANUFACTURED OR INTENDED FOR USE OR RESALE FOR THE OPERATION OF NUCLEAR FACILITIES, THE NAVIGATION, CONTROL OR COMMUNICATION SYSTEMS FOR AIRCRAFT OR OTHER TRANSPORTATION, AIR TRAFFIC CONTROL, LIFE SUPPORT OR LIFE SUSTAINING APPLICATIONS, WEAPONS SYSTEMS, OR ANY OTHER APPLICATION IN A HAZARDOUS ENVIRONMENT, OR REQUIRING FAIL-SAFE PERFORMANCE, OR IN WHICH THE FAILURE OF PRODUCTS COULD LEAD DIRECTLY TO DEATH, PERSONAL INJURY, OR SEVERE PHYSICAL OR ENVIRONMENTAL DAMAGE (COLLECTIVELY, "HIGH RISK APPLICATIONS").

You understand and agree that your use of Kontron devices as a component in High Risk Applications is entirely at your risk. To minimize the risks associated with your products and applications, you should provide adequate design and operating safeguards. You are solely responsible for compliance with all legal, regulatory, safety, and security related requirements concerning your products. You are responsible to ensure that your systems (and any Kontron hardware or software components incorporated in your systems) meet all applicable requirements. Unless otherwise stated in the product documentation, the Kontron device is not provided with error-tolerance capabilities and cannot therefore be deemed as being engineered, manufactured or setup to be compliant for implementation or for resale as device in High Risk Applications. All application and safety related information in this document (including application descriptions, suggested safety measures, suggested Kontron products, and other materials) is provided for reference only.

Revision History

| Revision | Brief Description of Changes | Date of Issue | Author/Editor |
|----------|--|---------------|---------------|
| 1.0 | Initial version | 2020-Jan-16 | CW |
| 1.1 | Updated Table 3 with Power Consumption (typ). Added a scope of delivery (Table 1), Limited power Source (LPS) Info and power specification information with brownout and protection. | 2020-Aug-17 | CW |

Terms and Conditions

Kontron warrants products in accordance with defined regional warranty periods. For more information about warranty compliance and conformity, and the warranty period in your region, visit <http://www.kontron.com/terms-and-conditions>.

Kontron sells products worldwide and declares regional General Terms & Conditions of Sale, and Purchase Order Terms & Conditions. Visit <http://www.kontron.com/terms-and-conditions>.

For contact information, refer to the corporate offices contact information on the last page of this user guide or visit our website [CONTACT US](#).

Customer Support

Find Kontron contacts by visiting: <http://www.kontron.com/support>.

Customer Service

As a trusted technology innovator and global solutions provider, Kontron extends its embedded market strengths into a services portfolio allowing companies to break the barriers of traditional product lifecycles. Proven product expertise coupled with collaborative and highly-experienced support enables Kontron to provide exceptional peace of mind to build and maintain successful products.

For more details on Kontron's service offerings such as: enhanced repair services, extended warranty, Kontron training academy, and more visit <http://www.kontron.com/support-and-services/services>.

Customer Comments

If you have any difficulties using this user guide, discover an error, or just want to provide some feedback, contact [Kontron support](#). Detail any errors you find. We will correct the errors or problems as soon as possible and post the revised user guide on our website.

Symbols

The following symbols may be used in this user guide

⚠ DANGER

DANGER indicates a hazardous situation which, if not avoided, will result in death or serious injury.

⚠ WARNING

WARNING indicates a hazardous situation which, if not avoided, could result in death or serious injury.

NOTICE

NOTICE indicates a property damage message.

⚠ CAUTION

CAUTION indicates a hazardous situation which, if not avoided, may result in minor or moderate injury.



Electric Shock!

This symbol and title warn of hazards due to electrical shocks (> 60 V) when touching products or parts of products. Failure to observe the precautions indicated and/or prescribed by the law may endanger your life/health and/or result in damage to your material.



ESD Sensitive Device!

This symbol and title inform that the electronic boards and their components are sensitive to static electricity. Care must therefore be taken during all handling operations and inspections of this product in order to ensure product integrity at all times.



HOT Surface!

Do NOT touch! Allow to cool before servicing.



Laser!

This symbol inform of the risk of exposure to laser beam and light emitting devices (LEDs) from an electrical device. Eye protection per manufacturer notice shall review before servicing.



This symbol indicates general information about the product and the user guide.

This symbol also indicates detail information about the specific product configuration.



This symbol precedes helpful hints and tips for daily use.

For Your Safety

Your new Kontron product was developed and tested carefully to provide all features necessary to ensure its compliance with electrical safety requirements. It was also designed for a long fault-free life. However, the life expectancy of your product can be drastically reduced by improper treatment during unpacking and installation. Therefore, in the interest of your own safety and of the correct operation of your new Kontron product, you are requested to conform with the following guidelines.

High Voltage Safety Instructions

As a precaution and in case of danger, the power connector must be easily accessible. The power connector is the product's main disconnect device.

⚠ CAUTION

Warning

All operations on this product must be carried out by sufficiently skilled personnel only.

⚠ CAUTION



Electric Shock!

Before installing a non hot-swappable Kontron product into a system always ensure that your mains power is switched off. This also applies to the installation of piggybacks. Serious electrical shock hazards can exist during all installation, repair, and maintenance operations on this product. Therefore, always unplug the power cable and any other cables which provide external voltages before performing any work on this product.

Earth ground connection to vehicle's chassis or a central grounding point shall remain connected. The earth ground cable shall be the last cable to be disconnected or the first cable to be connected when performing installation or removal procedures on this product.

Special Handling and Unpacking Instruction

NOTICE



ESD Sensitive Device!

Electronic boards and their components are sensitive to static electricity. Therefore, care must be taken during all handling operations and inspections of this product, in order to ensure product integrity at all times.

⚠ CAUTION

Handling and operation of the product is permitted only for trained personnel within a work place that is access controlled. Follow the "General Safety Instructions for IT Equipment" supplied with the product.

Do not handle this product out of its protective enclosure while it is not used for operational purposes unless it is otherwise protected.

Whenever possible, unpack or pack this product only at EOS/ESD safe work stations. Where a safe work station is not guaranteed, it is important for the user to be electrically discharged before touching the product with his/her hands or tools. This is most easily done by touching a metal part of your system housing.

It is particularly important to observe standard anti-static precautions when changing piggybacks, ROM devices, jumper settings etc. If the product contains batteries for RTC or memory backup, ensure that the product is not placed on conductive surfaces, including anti-static plastics or sponges. They can cause short circuits and damage the batteries or conductive circuits on the product.

Lithium Battery Precautions

If your product is equipped with a lithium battery, take the following precautions when replacing the battery.

CAUTION

Danger of explosion when replacing with wrong type of battery. Replace only with the same or equivalent battery type recommended by the manufacturer. The lithium battery type must be UL recognized.

General Instructions on Usage

In order to maintain Kontron's product warranty, this product must not be altered or modified in any way. Changes or modifications to the product, that are not explicitly approved by Kontron and described in this user guide or received from Kontron Support as a special handling instruction, will void your warranty.

This product should only be installed in or connected to systems that fulfill all necessary technical and specific environmental requirements. This also applies to the operational temperature range of the specific board version that must not be exceeded. If batteries are present, their temperature restrictions must be taken into account.

In performing all necessary installation and application operations, only follow the instructions supplied by the present user guide.

Keep all the original packaging material for future storage or warranty shipments. If it is necessary to store or ship the product then re-pack it in the same manner as it was delivered.

Special care is necessary when handling or unpacking the product. See Special Handling and Unpacking Instruction.

Quality and Environmental Management

Kontron aims to deliver reliable high-end products designed and built for quality, and aims to complying with environmental laws, regulations, and other environmentally oriented requirements. For more information regarding Kontron's quality and environmental responsibilities, visit <http://www.kontron.com/about-kontron/corporate-responsibility/quality-management>.

Disposal and Recycling

Kontron's products are manufactured to satisfy environmental protection requirements where possible. Many of the components used are capable of being recycled. Final disposal of this product after its service life must be accomplished in accordance with applicable country, state, or local laws or regulations.

WEEE Compliance

The Waste Electrical and Electronic Equipment (WEEE) Directive aims to:

- ▶ Reduce waste arising from electrical and electronic equipment (EEE)
- ▶ Make producers of EEE responsible for the environmental impact of their products, especially when the product become waste
- ▶ Encourage separate collection and subsequent treatment, reuse, recovery, recycling and sound environmental disposal of EEE
- ▶ Improve the environmental performance of all those involved during the lifecycle of EEE



Environmental protection is a high priority with Kontron.
Kontron follows the WEEE directive
You are encouraged to return our products for proper disposal.

Table of Contents

| | |
|---|-----------|
| Symbols | 6 |
| For Your Safety | 7 |
| High Voltage Safety Instructions | 7 |
| Special Handling and Unpacking Instruction | 7 |
| Lithium Battery Precautions..... | 8 |
| General Instructions on Usage | 8 |
| Quality and Environmental Management | 8 |
| Disposal and Recycling..... | 8 |
| WEEE Compliance..... | 8 |
| Table of Contents | 9 |
| List of Tables | 10 |
| List of Figures | 10 |
| 1/ General Safety Instructions | 12 |
| 1.1. Electrostatic Discharge (ESD)..... | 13 |
| 1.1.1. Grounding Methods | 13 |
| 2/ Introduction | 14 |
| 3/ Shipping and Unpacking | 15 |
| 3.1. Packaging..... | 15 |
| 3.2. Unpacking..... | 15 |
| 3.3. Scope of Delivery..... | 15 |
| 3.4. Accessories | 15 |
| 3.5. Type Label and Product Identification..... | 16 |
| 4/ Product Description | 17 |
| 4.1. Product Views | 17 |
| 5/ Technical Specification | 19 |
| 5.1. Display Specification..... | 19 |
| 5.1.1. PC Display Modes | 19 |
| 5.2. Power Specification..... | 21 |
| 5.2.1. Power Supply Protection Requirements..... | 22 |
| 5.3. Environmental Specification..... | 22 |
| 5.4. Certificates, Directives and Standards..... | 22 |
| 5.5. Mechanical Specification | 22 |
| 5.5.1. 15" Chassis..... | 23 |
| 5.5.2. 15" Monitor with Front Frame (bezel)..... | 23 |
| 5.5.3. 17" Chassis | 24 |
| 5.5.4. 17" Monitor with Front Frame (bezel) | 24 |
| 5.5.5. 19" Chassis | 25 |
| 5.5.6. 19" Monitor with Front Frame (bezel) | 25 |
| 6/ Installation and Starting Up | 26 |
| 6.1. Installation | 26 |
| 6.2. Connecting the Cables | 26 |
| 6.2.1. Connecting the Signal Cables | 27 |
| 6.2.2. Setting up the Touch Screen (option) | 27 |
| 6.2.3. Connecting to Power..... | 27 |
| 6.2.4. Wiring the DC Mating Power Connector..... | 28 |
| 6.3. Starting Up..... | 29 |

| | |
|--|-----------|
| 6.4. Setting up the Display Options | 30 |
| 7/ Connectors | 31 |
| 7.1. DC-IN Power Jack (additional connector)..... | 31 |
| 7.2. DVI - D Connector | 31 |
| 7.3. VGA Connector | 31 |
| 7.4. Serial Port..... | 32 |
| 7.5. USB Port | 32 |
| 7.6. Power Connector | 32 |
| 7.7. DP Connector (option)..... | 32 |
| 8/ OSD Control Panel..... | 33 |
| 8.1. OSD Control Panel Buttons | 33 |
| 8.2. OSD Screen Functions..... | 33 |
| 8.2.1. OSD Windows- Example Brightness..... | 35 |
| 8.2.2. OSD Window – Example Color Temperature..... | 35 |
| 9/ Technical Support..... | 36 |
| 9.1. Trouble Shooting..... | 36 |
| 9.2. Technical Support | 37 |
| 9.3. Returning Defective Merchandise | 37 |
| 9.4. Warranty | 38 |
| 10/ Storage, Transportation and Maintenance | 39 |
| 10.1. Storage..... | 39 |
| 10.2. Transportation | 39 |
| 10.3. Maintenance..... | 39 |
| 10.3.1. Cleaning the Display | 39 |
| Appendix A: List of Acronyms..... | 40 |
| About Kontron | 41 |

List of Tables

| | |
|--|----|
| Table 1: Scope of Delivery | 15 |
| Table 2: Accessories | 15 |
| Table 3: TFT LCD Display Technical Specification | 19 |
| Table 4: PC Display Modes 15"/17"/19" | 19 |
| Table 5: PC Display Modes 19" Wide..... | 20 |
| Table 6: Electrical Specification..... | 21 |
| Table 7: Environmental Specification | 22 |
| Table 8: Standards, Certification and Directives..... | 22 |
| Table 9: Mechanical Specification | 22 |
| Table 10: OSD Control Panel Functions | 33 |
| Table 11: OSD Screen Icon Functions..... | 34 |
| Table 12: Trouble Shooting Information | 36 |
| Table 13: List of Acronyms (Example) | 40 |

List of Figures

| | |
|---|----|
| Figure 1: Open Frame Monitor | 14 |
| Figure 2: Open Frame Monitor with Front Frame (bezel) | 14 |
| Figure 3: Open Frame Monitor 19" Rackmount including OSD..... | 14 |
| Figure 4: Front Side..... | 17 |
| Figure 5: Rear Side..... | 18 |
| Figure 6: 15" Chassis | 23 |

Figure 7: 15" Monitor with Bezel 23

Figure 8: 17" Chassis 24

Figure 9: 17" Monitor with Bezel 24

Figure 10: 19" Chassis 25

Figure 11: 19" Monitor with Bezel..... 25

Figure 12: Mounting Screw (Minimum Requirement)..... 26

Figure 13: DC Mating Power Connector 2-Pin, 12 VDC and 3-Pin, 24 VDC..... 28

Figure 14: Changing the Display Resolution 30

Figure 15: Interface and Power Connectors..... 31

Figure 16: OSD Control Panel Buttons..... 33

1/ General Safety Instructions

▲WARNING



Read and observe the instructions within this chapter that have been compiled for user's safety and to ensure accordance with regulations. If the following General Safety Instructions are not observed, it could lead to injuries to the operator and/or damage to the product. Kontron is exempt from accident liability, also during the warranty period if the instructions within this user guide are not observed.

The product has been built and tested according to the basic safety requirements for low voltage (LVD) applications and has left the manufacturer in safety-related, flawless condition. To maintain this condition and also to ensure safe operation, the operator must not only observe the correct operating conditions for the product but also the following general safety instructions:

- ▶ The product must be used in accordance with the instructions for use within this user guide.
- ▶ The electrical installations must correspond to the requirements of the local (country-specific) regulations.
- ▶ Take care that there are no cables, particularly power cables, in areas where persons can trip over the cables.
- ▶ If supplied, only use the supplied power cable.
- ▶ Do not use a damaged power cable.
- ▶ For DC power connection: the DC power source should be able to be switched off and switched on via an isolating switch. The product is only completely disconnected from the DC main power source, when the DC power cable is disconnected either, from the power source or the product. Therefore, the DC power cable and its connectors must always remain easily accessible.
- ▶ For AC power connection via external AC/DC adapter: the main power cable of the external AC/DC adapter serves as a disconnecting device. For this reason, the outlet of the AC power source must be located near the product and be easily accessible.
- ▶ Do not place the product in direct sunlight, near heat sources or in a damp place. Make sure the product has adequate ventilation.
- ▶ Only devices or parts that fulfill the safety requirements as stipulated by the applied safety standards may be connected to the available interfaces.
- ▶ All plugs on the connection cables must be screwed or locked to the housing.
- ▶ The product generates heat during operation, make sure it is adequately ventilated. Do not cover the air intake and exhaust openings of the product.
- ▶ Handling and operation of the product is only permitted for trained personnel within a work place that is access controlled.
- ▶ Maintenance or repair on the open product may only be carried out by trained personnel authorized by Kontron that are aware of the associated dangers.
- ▶ When accessing internal components the product must be switched off and disconnected from the power source.
- ▶ Only connect to an external power supply that meets the criteria for Safety Extra Low Voltage (SELV), and Limited Power Source (LPS) of IEC 60950-1 or PS2 of IEC 62368-1.

Additional safety instructions for DC power supply circuits:

- ▶ To guarantee safe operation of products with DC power supply voltages larger than 60 volts DC or a power consumption larger than 120 VA, observe that:
 - ▶ Product is set up, installed and operated in a room or enclosure marked with "RESTRICTED ACCESS", if there are no safety messages such as safety signs and labels on the product.
 - ▶ Do not touch either directly or indirectly, cables or parts without insulation in electrical circuits with dangerous voltage or power.
 - ▶ Reliable protective earth connection is provided
 - ▶ Suitable, easily accessible disconnecting device is used in the application (e.g. overcurrent protective device), if the product cannot be disconnected
 - ▶ A disconnect device, if provided in or as part of the equipment, must disconnect both poles simultaneously
 - ▶ Interconnecting power circuits of different devices cause no electrical hazards
- ▶ A sufficient dimensioning of the power cable wires must be selected – according to the maximum electrical specifications on the product's type label – as stipulated by the applied safety standards.
- ▶ The product do not generally fulfill the requirements for "centralized DC power systems" as stipulated by the applied safety standards and therefore may not be connected to such devices!

1.1. Electrostatic Discharge (ESD)

A sudden discharge of electrostatic electricity can destroy static-sensitive devices or micro-circuitry. Therefore, proper packaging and grounding techniques are necessary precautions to prevent damage.

Always take the following precautions:



ESD Sensitive Device!

Follow the electrostatic discharge (ESD) precautions for components that are sensitive to ESD. When handling ESD sensitive components use a clean, flat and ESD-safe workstation and always be properly grounded. Failure to observe this warning notice may result in damage to the product and internal components.

For more Information, see the Special Handling and Unpacking Instruction within this user guide and the Grounding Methods below.

1.1.1. Grounding Methods

The following measures help to avoid electrostatic damage to the product:

- ▶ Cover workstations with approved antistatic material. Always wear a wrist strap connected to the workplace, as well as properly grounded tools and equipment.
- ▶ Use antistatic mats, heel straps, or air ionizers for more protection.
- ▶ Always handle electrostatically sensitive components by their edge or by their casing.
- ▶ Avoid contact with pins, leads, or circuitry.
- ▶ Switch off power and input signals before inserting and removing connectors or connecting test equipment.
- ▶ Keep the work area free of non-conductive materials such as ordinary plastic assembly aids and styrofoam.
- ▶ Use field service tools such as cutters, screwdrivers, and vacuum cleaners that are conductive.
- ▶ Always place drives and boards with the PCB-assembly-side down on the foam.

2/ Introduction

This user guide specifies the key technical features of the Open Frame Monitor and includes detailed information and guidelines for set up, installation, maintenance, transport and storage. The Open Frame Monitor is an industrial monitor used for cost effective visualization, with a robust design that meets industrial grade requirements while offering reliability and maintenance free operation.

The Open Frame Monitor is a lightweight monitor available in a variety of sizes (15" / 17" / 19") and front variants (Frame, Bezel and 19" Rack) for easy installation in existing and new fronts. Additionally, the Open Frame Monitor supports modular configuration with touch and power options.

The TFT LCD display incorporates a color active matrix thin-film-transistor (TFT) liquid crystal display for superior performance. The maximum resolution is ideal for displaying complex graphics and high definition images. Other capabilities include an audio system, OSD (On Screen Display) controls and touch options.

Key features are:

- ▶ Industrial Grade – robust, reliable, versatile and maintenance free
- ▶ Lightweight open frame monitor for easy installation in existing fronts
- ▶ TFT LCD display: 15" / 17" / 19"
- ▶ Modular configuration:
- ▶ Touch screen: capacitive, resistive or protection glass
- ▶ Front: diverse options, e.g. aluminum, stainless steel, for 19" rackmount etc.

Figure 1: Open Frame Monitor

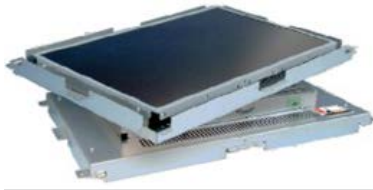

Figure 2: Open Frame Monitor with Front Frame (bezel)



Figure 3: Open Frame Monitor 19" Rackmount including OSD



3/ Shipping and Unpacking

3.1. Packaging

The Open Frame Monitor is delivered individually in a product specific cardboard package designed to provide adequate protection.

3.2. Unpacking

To unpack the product, perform the following:

1. Remove packaging.
2. Do not discard the original packaging. Keep the original packaging for future transportation or storage.
3. Check the delivery for completeness by comparing the delivery with the original order.
4. Keep the associated paperwork. It contains important information for handling the product.
5. Check the contents for visible shipping damage.
6. If you notice any shipping damage or inconsistencies between the contents and the original order, contact Kontron for help and information.

3.3. Scope of Delivery

Check that your delivery is complete, and contains the items listed below. If you discover damaged or missing items, contact your dealer.

Table 1: Scope of Delivery

| Delivered Item | Part Description |
|--|---|
| Open Frame Monitor | 15" / 17" / 19" monitor ordered with configuration options such as frame and protective glass, factory installed. |
| General Safety Instructions for IT Equipment | General safety instruction when operating or handling IT equipment |

3.4. Accessories

Table 2: Accessories

| Part | Part Number | Part Description |
|------------------------|----------------|---|
| 12 VDC Kit | Zubehör-DD | Power supply 12 VDC and: Mating power connector (2-pin, 12 VDC), VGA-cable 1.8 m and DVI cable 1.8 m |
| 12 VDC Power Connector | 828-0015 | Mating power connector (2-pin, 12 VDC) Not delivered with the product must be ordered separately) |
| 24 VDC Kit | Zubehör-24 | Mating power connector (3-pin, 24 VDC), VGA-cable 1.8 m and DVI cable 1.8 m |
| 24 VDC Power Connector | 828-0117 | Mating power connector (3-pin, 24 VDC) Not delivered with the product must be ordered separately) |
| USB Touch Cable | 840-0292 | USB A-A cable 1.8 m |
| Serial Touch Cable | 840-0072 | Serial cable 2 m |
| Packaging | PW40-100023-01 | Specific packaging for Open Frame Monitor (Mandatory option) |

3.5. Type Label and Product Identification

The type label contains specific product information, including:

- ▶ Model
- ▶ Serial Number (S/N)
- ▶ Technical data (voltage and current rating)
- ▶ Certification/standards markings

4/ Product Description

Before working with the Open Frame Monitor, Kontron recommends that users take a few minutes to learn about the Open Frame Monitor's various parts and to observe the instructions and any warning notices within this user guide.

4.1. Product Views

Figure 4: Front Side

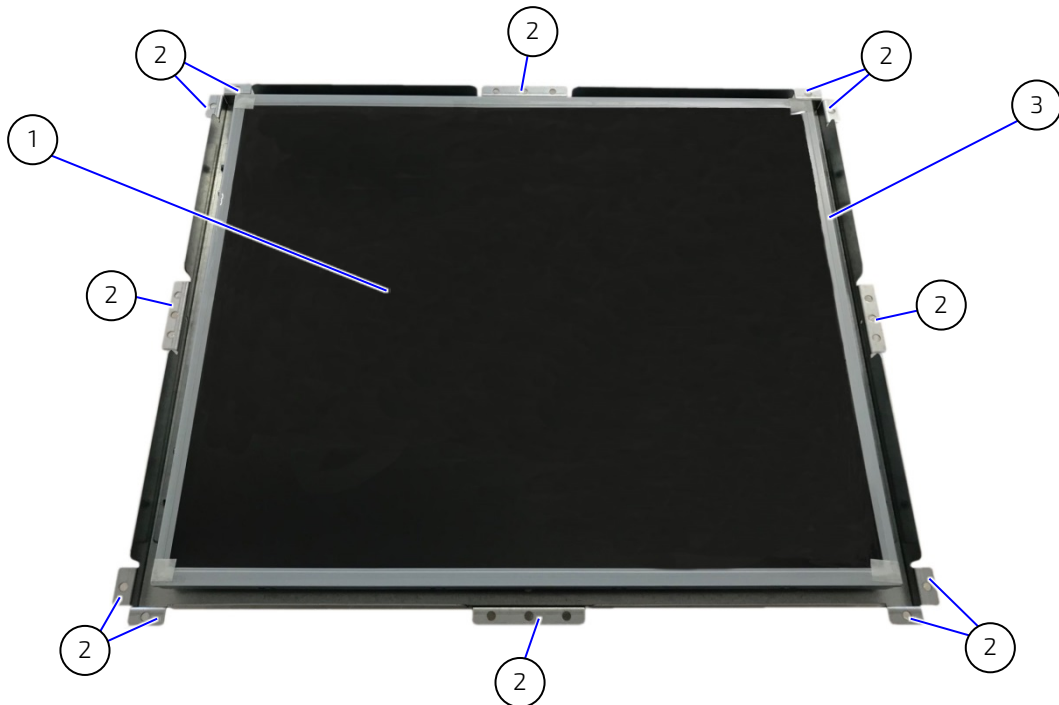

- | | | | |
|---|--------------------------------------|---|-------|
| 1 | TFT LCD display screen | 3 | Frame |
| 2 | Mounting brackets(corner and middle) | | |

Figure 5: Rear Side

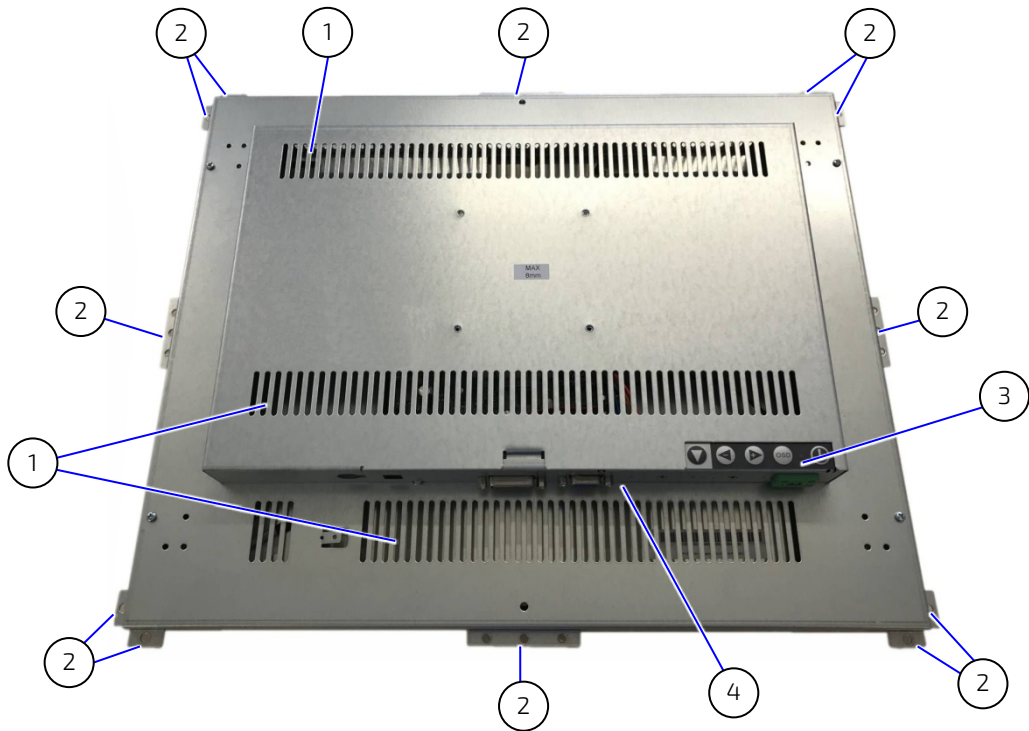

- | | | | |
|---|---------------------------------------|---|---|
| 1 | Ventilation holes | 3 | OSD control panel |
| 2 | Mounting brackets (corner and middle) | 4 | Connector panel for interface and power cable |

5/ Technical Specification

5.1. Display Specification

Table 3: TFT LCD Display Technical Specification

| Display Size | 15" Spec. | 17" Spec. | 19" Spec. (4:3) |
|-------------------|--|----------------------------|----------------------------|
| Resolution | 1024 x 768 (XGA) | 1280 x 1024 (SXGA) | 1280 x 1024 (SXGA) |
| Contrast Ratio | 600 : 1 | 1000 : 1 | 1000 : 1 |
| Brightness | 250 cd/m ² | 300 cd/m ² | 350 cd/m ² |
| View Angle | H 160° / V 170° | H 160° / V 170° | H 160° / V 170° |
| LED Backlight | Lifetime => 30,000 hours | Lifetime => 50,000 hours | Lifetime => 50,000 hours |
| Power Consumption | On: <40 W Typical: 18 W | On: <45 W Typical: 28 W | On: <46 W Typical: 28 W |
| Colors | 16.7 Million | | |
| Touch Screen | Protection glass /Capacitive touch /Resistive touch | | |
| Front Option | Front frame dark grey / Aluminium / Stainless Steel Front for 19" rackmount With or without OSD-buttons | | |
| Video Interfaces | 1x VGA + 1x DVI or 1x VGA + 1x DVI + 1x DP | | |
| Touch Interfaces | USB or Serial | | |
| Power | 12 VDC/ 24 VDC option (10 VDC to 32 VDC) | | |
| Operating System | Windows7, Windows 8.1 incl. Embedded, Windows 10 IoT, Linux | | |
| Options | Video Interfaces HDMI, VGA and 1x FBAS Touch controller with serial port and USB Panel-PC possible on project base | | |

5.1.1. PC Display Modes

Table 4: PC Display Modes 15"/17"/19"

| Mode | Model | Resolution | H Freq (KHz) | V Freq (Hz) |
|------|-------------|-------------|--------------|-------------|
| 1 | 15" 17" 19" | 640 x 350 | 31.469 | 70.087 |
| 2 | 15" 17" 19" | 640 x 400 | 31.469 | 59.940 |
| 3 | 15" 17" 19" | 640 x 480 | 31.469 | 59.940 |
| 4 | 15" 17" 19" | 640 x 480 | 37.500 | 75.000 |
| 5 | 15" 17" 19" | 800 x 600 | 37.879 | 60.317 |
| 6 | 15" 17" 19" | 800 x 600 | 46.875 | 75.000 |
| 7 | 15" 17" 19" | 1024 x 768 | 48.363 | 60.004 |
| 8 | 15" 17" 19" | 1024 x 768 | 60.023 | 75.029 |
| 9 | 17" 19" | 1280 x 1024 | 63.981 | 60.020 |
| 10 | 17" 19" | 1280 x 1024 | 79.976 | 75.025 |

Table 5: PC Display Modes 19" Wide

| Mode | Resolution | H Freq (KHz) | V Freq (Hz) |
|------|------------|--------------|-------------|
| 1 | 640 x 350 | 31.469 | 70.087 |
| 2 | 640 x 400 | 31.469 | 59.940 |
| 3 | 640 x 480 | 31.469 | 59.940 |
| 4 | 640 x 480 | 37.500 | 75.000 |
| 5 | 800 x 600 | 37.879 | 60.317 |
| 6 | 800 x 600 | 46.875 | 75.000 |
| 7 | 1024 x 768 | 48.363 | 60.004 |
| 8 | 1024 x 768 | 60.023 | 75.029 |
| 9 | 1360 x 768 | 47.712 | 60.015 |
| 10 | 1440 x 900 | 55.935 | 59.887 |

5.2. Power Specification

The Open Frame Monitor is powered from an external power supply. Kontron recommends the use of the power supply listed in Table 2: Accessories; chosen to meet the product's power specification and power protection requirements. The Open Frame Monitor must be powered exclusively by a power supply delivering the electrical specification input rating (Table 6) and complying with the requirements of Safety Extra Low Voltage (SELV) and Limited Power Source (LPS) of IEC 60950-1 or (PS2) of IEC 62368-1.



Kontron recommends the use of the Kontron specified PSU, see Table 2: Accessories.

The Open Frame Monitor's nominal input voltage is 12 VDC or optionally 24 VDC. The Open Frame Monitor's connector panel includes two separate 12 VDC power connectors (one 2-pin DC power connector and one 12 VDC power jack). Only one 12 VDC connector may be connect to the Open Frame Monitor's 12 VDC power source.

For 24 VDC requirements, an optional 3-pin 24 VDC connector replaces the standard 2-pin 12 VDC connector.

WARNING

Only one 12 VDC connector may be connect to the Open Frame Monitor's 12 VDC power source.

Table 6: Electrical Specification

| | |
|-------------------------|---|
| Input Voltage (nominal) | 12 VDC (optional 24 VDC ^[1]) |
| Input Current | 5 A Max. |
| Input Power | 60 W (Max.) |
| Holdup Time | 10mS |
| Ripple and Noise | 100 mVp-p (Max.) |

^[1] The 3-pin 24 VDC power connector, replaces the standard 2-pin 12 VDC connector

CAUTION

Only connect to a power supply delivering the specified input rating and complying with the requirements of Safety Extra Low Voltage (SELV) and Limited Power Source (LPS) of IEC 60950-1 or (PS2) of IEC 62368-1.

NOTICE

Ensure the power supply is used according to the manufacture's instructions.

5.2.1. Power Supply Protection Requirements

The used external power supply is required to incorporate protection features such as over current protection, Inrush current protection, over voltage protection and undervoltage (brownout) protection, to protect the product against fluctuations and interruptions in the delivered DC power supply.

NOTICE

If a under voltage (brownout) condition occurs the used power supply must remain in the "off state" for a time long enough to allow internal voltages to discharge sufficiently. Failure to observe this "off state" may lead to parts of the product or peripherals working incorrectly or suffering a reduction of MTBF. The minimum "off state" to allow internal voltages to discharge sufficiently, is dependent on the power supply and additional electrical factors. To determine the required "off state" each case must be considered individually. For more information, contact Kontron Support.

5.3. Environmental Specification

Table 7: Environmental Specification

| Display Size | 15" Spec. | 17" Spec. | 19" Spec. (4:3) |
|-----------------------|----------------------------------|-----------|-----------------|
| Operating Temperature | 0°C to 45°C | | |
| Storage Temperature | -15°C to 70°C | | |
| Humidity | 10% ~ 90% @ 39°C, non-condensing | | |
| Altitude | Up to 10, 000 ft (3,000m) | | |
| RoHS Compliant | Yes | | |

5.4. Certificates, Directives and Standards

The Open Frame Monitor conforms to CE declaration and additional standard compliancy information. If users modify and/or add to the product the prerequisites for the CE conformity declaration, (safety requirements) may no longer apply.

Table 8: Standards, Certification and Directives

| | | | |
|--------------|----------------------------|----------------------------------|--|
| Certificates | CE (12 VDC) | | |
| EMC | EN55022 Class A | | |
| Shock | According to EN 60068-2-27 | 15 G, 11 ms duration (half sine) | |
| Vibration | According to EN 60068-2-6 | 10 Hz - 500 Hz: 1G/3 axis | |

5.5. Mechanical Specification

Table 9: Mechanical Specification

| Display Size | 15" Spec. | 17" Spec. | 19" Spec. (4:3) |
|------------------|---|-----------|-----------------|
| Cooling | Fanless passive cooling | | |
| Weight | 3.5Kgs | 4.7Kgs | 5.1 Kgs |
| Color | RAL 7021/Black grey (front frame) RAL 7035 /Light grey (19" rackmount) | | |
| Protection Class | Front up to IP65 | | |

For detailed mechanical information to mount the Open Frame Monitor, refer to the dimensions diagrams in this chapter showing the main mechanical dimensions for the Chassis and Front Frame (bezel) variants.

5.5.1. 15" Chassis

Figure 6: 15" Chassis

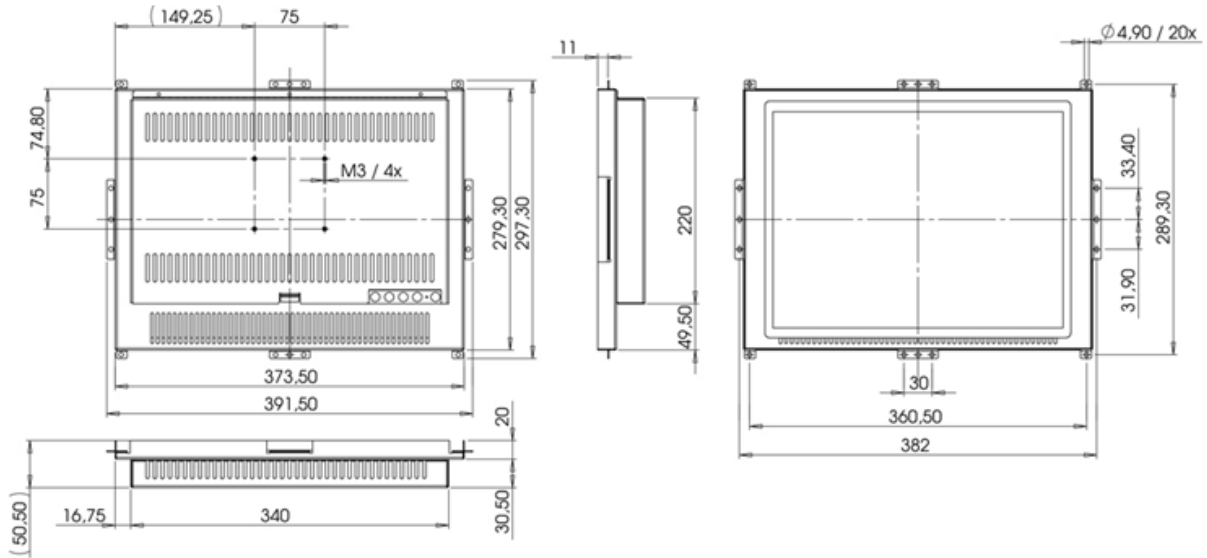

5.5.2. 15" Monitor with Front Frame (bezel)

Figure 7: 15" Monitor with Bezel

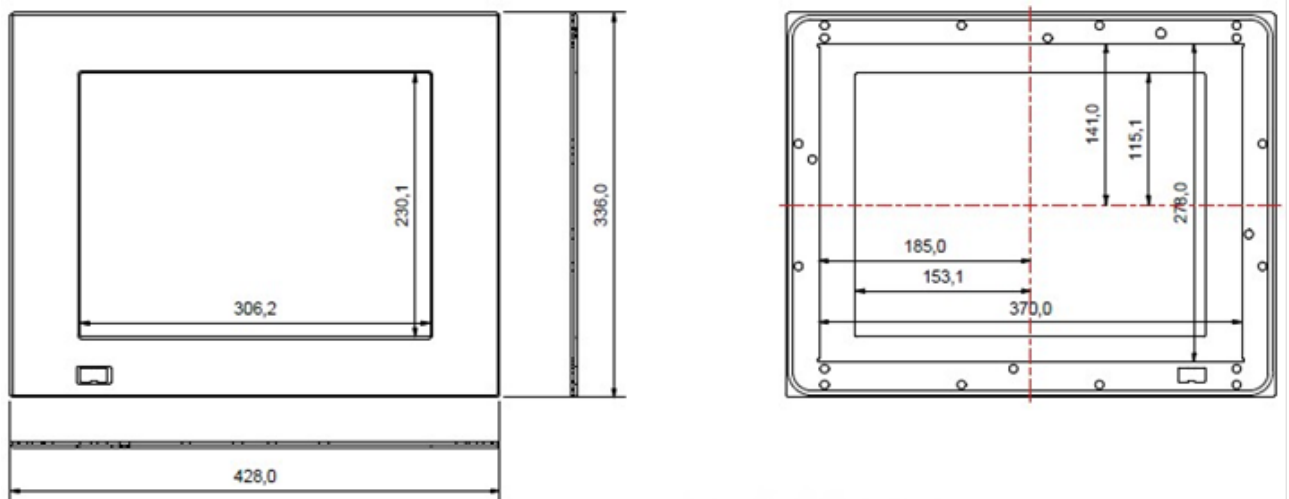

5.5.3. 17" Chassis

Figure 8: 17" Chassis

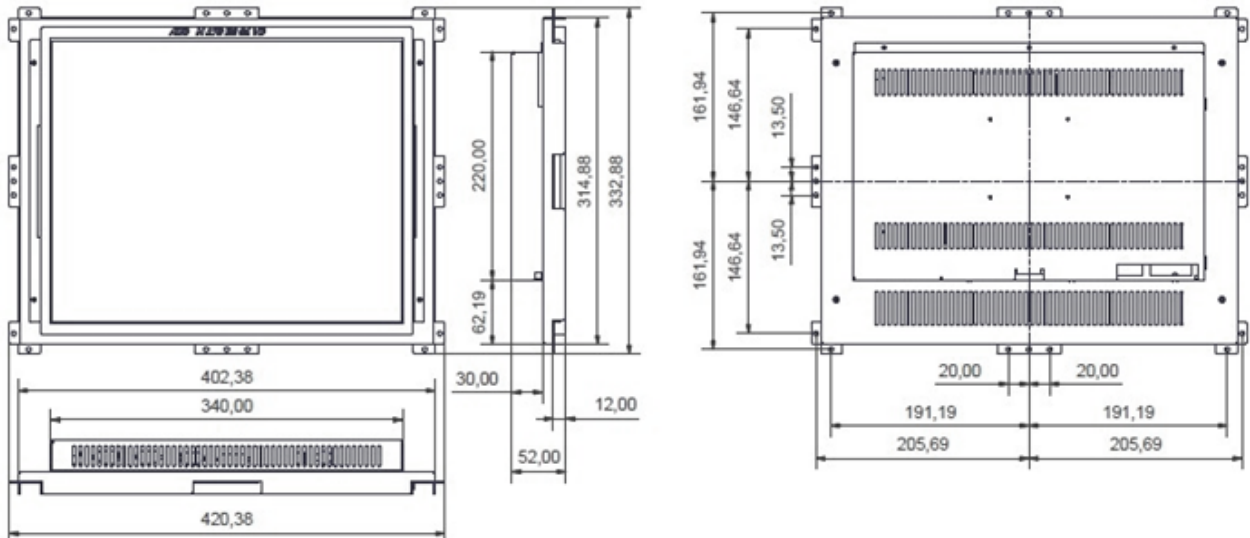

5.5.4. 17" Monitor with Front Frame (bezel)

Figure 9: 17" Monitor with Bezel

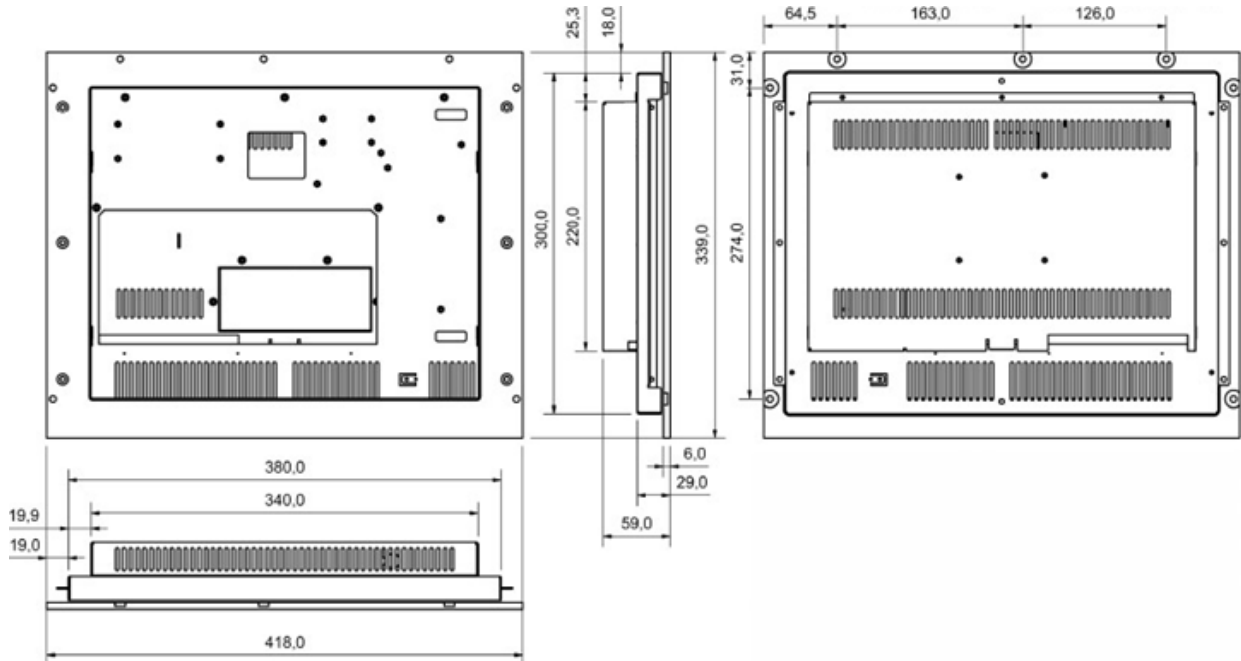

5.5.5. 19" Chassis

Figure 10: 19" Chassis

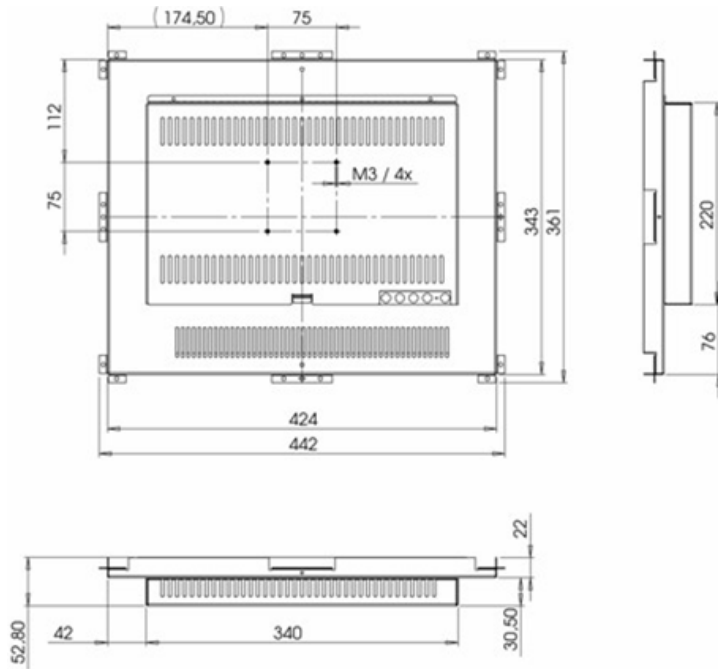

5.5.6. 19" Monitor with Front Frame (bezel)

Figure 11: 19" Monitor with Bezel

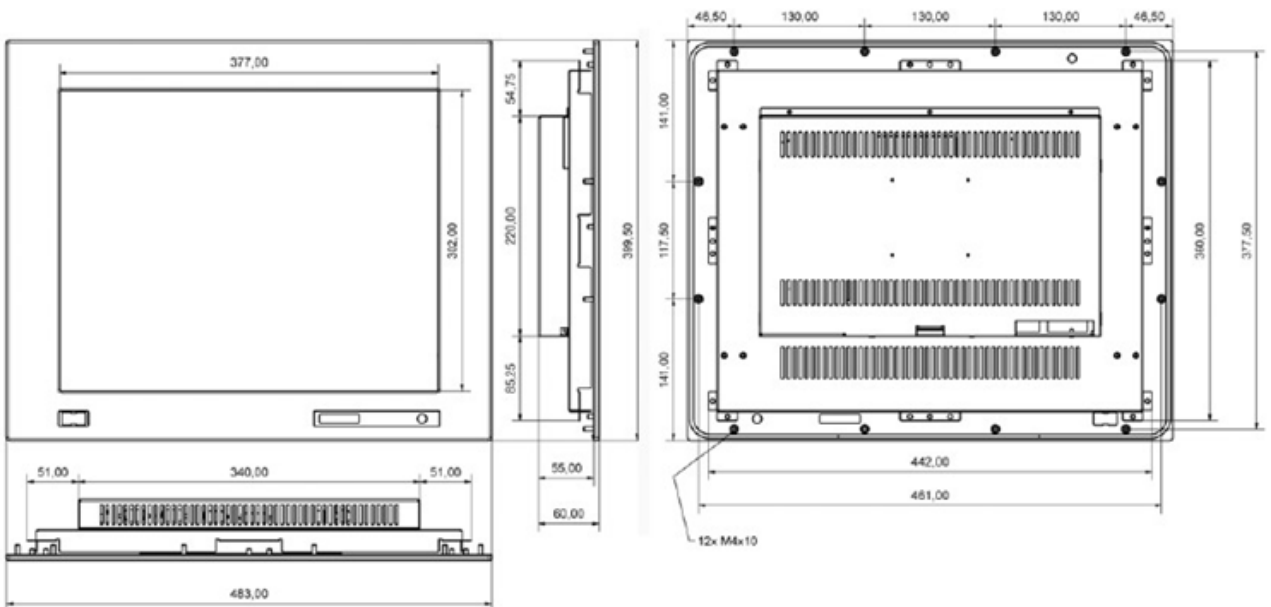

6/ Installation and Starting Up

6.1. Installation

The Open Frame Monitor is a lightweight monitor available in a variety of sizes (15" / 17" / 19") and front variants (Metal Frame/ Bezel/ 19" Rack) for easy installation in existing and new fronts.

To install, the Open Frame Monitor, perform the following:

1. Choose screws that suit the mounting surface's requirements.
2. Attach to the mounting surface using the mounting brackets (Figure 4, pos.2). The minimum screw requirement is eight screws with three screws on the top side and bottom sides (two corner mounting bracket screws and one middle mounting bracket screw) and one screw on the right side and left side (one middle mounting bracket screw) to secure the Open Frame Monitor, see Figure 12.

Figure 12: Mounting Screw (Minimum Requirement)

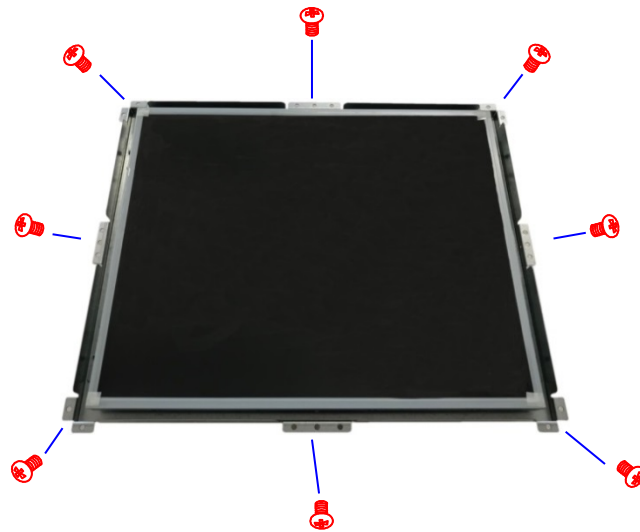

⚠ CAUTION

Ensure the Open Frame Monitor is properly secured to the mounting surface, do not use less than the minimum requirement of screw and make sure the screws are located in the specified mounting brackets, shown in Figure 12.

6.2. Connecting the Cables

⚠ CAUTION

Ensure that both the Open Frame Monitor and PC system are switched off and the power cable is properly disconnected from the power connector or main power supply before connecting any I/O cables.

⚠ CAUTION

When connecting cables, following proper cabling procedures:

- Grounding pin is connected first and disconnected last
- Connect all I/O cables
- Power connection is the last connection

6.2.1. Connecting the Signal Cables

To connect signal cables to the Open Frame Monitor's connector panel, perform the following:

1. Ensure that both the Open Frame Monitor and PC system are switched off and disconnected from the main power supply.
2. Connect the video cable to the required video connector (VGA, DVI or optional DP) on the connector panel.
3. Connect the other end of the video cable to the PC system's equivalent video connector. Tighten any connector plugs to secure the VGA or DVI video cable.



The VGA and DVI cable not delivered with the product. To order the VGA and DVI cable, see Table 2: Accessories.

6.2.2. Setting up the Touch Screen (option)

To operate the Open Frame Monitor with touch functionality, perform the following:

1. Ensure that both the Open Frame Monitor and PC system are switched off and disconnected from the main power supply.
2. Connect either the USB Touch Cable to the USB Type A connector (Figure 15, pos.5) or the Serial Touch Cable to the RS 232 connector (Figure 15, pos.4).
3. Connect the other end of the cable to the PC system's equivalent connector.



The USB Touch Cable and Serial Touch Cable are not delivered with the product. To order the USB Touch Cable or Serial Touch Cable, see Table 2: Accessories.

6.2.3. Connecting to Power

⚠ WARNING

Kontron recommends the use of Kontron's PSU chosen to meet the product's power specification and power protection requirements, see Table 2: Accessories.

⚠ WARNING

Only connect to a PSU with a rated input voltage, power cable and the external overcharge protection that corresponds with the electrical specification on the product's type label and complies with the Safety Extra Low Voltage (SELV) requirements.

To connect the PSU to the Open Frame Monitor, perform the following:

1. Connect the power cable for your region to the PSU and the other end of the power cable to the mains power supply.
2. For 12 VDC- Connect the power supply's, other cable to either the DC-IN Power Jack (Figure 15, pos. 1) or the 2-pin, 12 VDC power connector (Figure 15, pos. 6) using wired DC mating power connector, see Chapter 6.4.1: Wiring the DC Mating Power Connector.

⚠ WARNING

Use only one of the 12 VDC power connectors (2-pin, 12 VDC or the DC-IN 12 VDC Jack).

- For 24 VDC - Connect to the power supply's, other cable to the 3-pin, 24 VDC power connector using the wired DC mating power connector, see Chapter 6.4.1: Wiring the DC Mating Power Connector.



The mating power connectors (2-pin, 12VDC and 3-pin, 24 VDC) are not delivered with the product. To order the required mating power connector, see Table 2: Accessories.

6.2.4. Wiring the DC Mating Power Connector

The mating connector for the DC power connector (2-pin, 12 VDC or 3-pin, 24 VDC) is available as a standalone part or as part of a kit, see Table 2: Accessories.

Figure 13: DC Mating Power Connector 2-Pin, 12 VDC and 3-Pin, 24 VDC

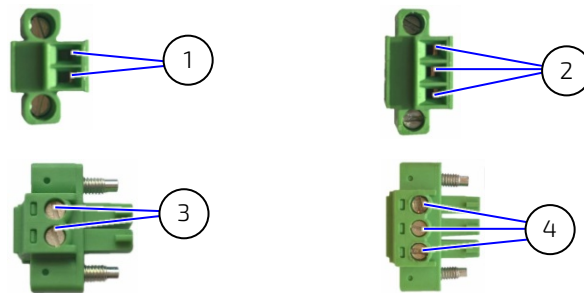

- | | | | |
|---|----------------------------------|---|--|
| 1 | Clamps to hold the wires (2-pin) | 3 | Screws to release/tighten the clamps hold on the wires (2-pin) |
| 2 | Clamps to hold the wires (3-pin) | 4 | Screws to release/tighten the clamps hold on the wires (3-pin) |

The connector is delivered without wires, to wire the DC mating power connector (2-pin, 12 VDC or 3-pin, 24 VDC), perform the following:

- Cut two (2-pin) or three (3-pin) 1 mm² AWG 18 isolated wires to the required length and strip 5 mm to 7 mm from each end.
- Prepare the wires by twisting the striped wire-ends and providing the wires with ferrules.
- Open the clamp on DC mating power connector far enough by turning the slotted pan head screws (Figure 13, pos. 3 or pos. 4) to create enough space to insert the end of the prepared wires.
- Insert the prepared wires into the corresponding DC mating power connector's clamp (Figure 13, pos. 1 or pos. 2). Make sure the polarity of the wires is correct.
- Fasten the slotted pan head screws to secure the wires in the DC mating power connector's clamps.

⚠ WARNING

The power connection wires must be clearly marked (+/GND) to ensure proper connection to the power connector and main power supply.

6.3. Starting Up

To start up the Open Frame Monitor connect the signal and power cables following proper cabling procedures.

⚠ CAUTION

Ensure that both the Open Frame Monitor and PC system are switched off and the power cable is properly disconnected from the power connector or main power supply before connecting any I/O cables.

To start up the Open Frame Monitor, perform the following:

1. Connect the signal cables, see Chapter 6.2.1: Connecting the Signal Cables.
2. To use the touch screen functionality, see Chapter 6.2.2: Setting up the Touch Screen (Option).
3. To connect the PSU, see Chapter 6.2.3: Connecting to Power.
4. The power indicator LED on the OSD panel turns green (Figure 16, pos. 2) to indicate the Open Frame Monitor is ready to be switched on.
5. Press the power button (Figure 16, pos. 1) to switch on and then set up the display options, see Chapter 6.4: Setting up the Display Options.

6.4. Setting up the Display Options

To set the best display resolution, refresh rate, and color options, perform the following:

1. Select the following in Windows:
Control Panel > Hardware and Sound>Display > Adjust Resolution > Resolution>
2. Click on the arrow (downward facing) to access the Resolution drop down list.
3. Move the arrow (Figure 14, Pos. 1) to the required resolution, and click OK.

Figure 14: Changing the Display Resolution

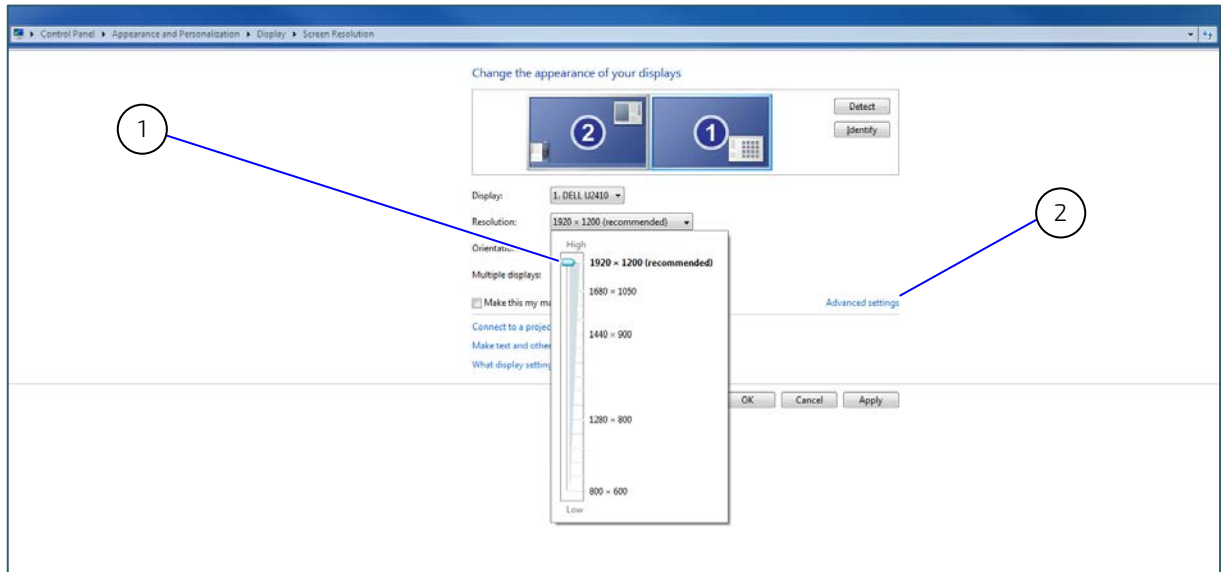

1 Arrow to change Resolution

2 Advanced Settings to change the refresh rate



The recommended resolutions for standard ratio LCD display sizes are:

- 15 " resolution 1024 x 768
- 17" resolution 1280 x 1024
- 19" resolution 1280 x 1024

4. Click on "Advanced Settings" (Figure 14, Pos. 2) and in the pop up window that appears click "Monitor". This displays the monitor type and the current refresh rate. Alter, the refresh rate if required. Kontron recommends a refresh rate of 75Hz.
5. Select "Set Auto Adjust" in the OSD control panel, to set an optimal color display automatically.

7/ Connectors

Figure 15: Interface and Power Connectors

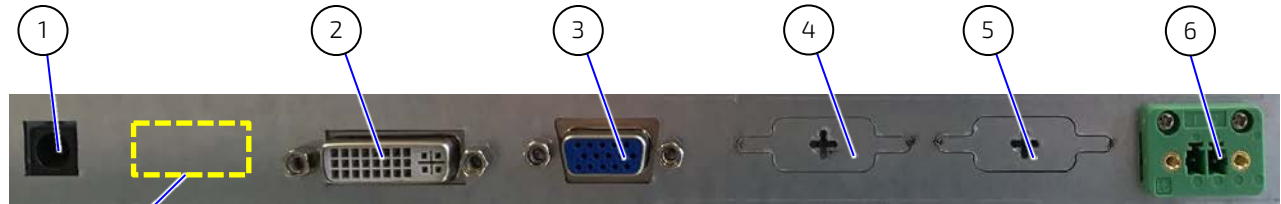

- | | |
|---|---|
| <p>1 DC-IN 12 VDC Jack</p> <p>2 DVI-D connector</p> <p>3 VGA connector</p> <p>4 RS 232 Connector (touch screen option) Shown here as a breakout</p> | <p>5 USB Type A port (touch screen option) Shown here as a breakout</p> <p>6 12 VDC Power connector 2-pin, 12 V DC, (Option 3-pin 24 VDC)</p> <p>7 Display Port (DP) connector (option) (Only position of connector is shown)</p> |
|---|---|

7.1. DC-IN Power Jack (additional connector)

| DC-in Power Jack Connector | Description |
|--|--|
|  | Connector for 12 V DC input power (+12 V DC inside & Ground outside) |

⚠ WARNING

Use only one of the 12 VDC power connectors (2-pin, 12 VDC or the DC-IN 12 VDC Jack).

7.2. DVI - D Connector

| DVI-D Connector | Description |
|---|------------------------------------|
|  | Connector for digital video signal |

7.3. VGA Connector

| VGA 15-pin D-Sub Connector | Description |
|---|--|
|  | Connector for analogue RGB Video signals |

7.4. Serial Port

For PCs with a serial port, Kontron supplies a serial port touch cable. For more information, see Table 2: Accessories.

| Serial Port | Description |
|---|---|
|  | RS232 Touch(DE-9) connector with thumb screws for "Serial Touch Cable" |

7.5. USB Port

For PCs with a USB port, Kontron supplies a USB touch cable. For more information, see Table 2: Accessories.

| USB Port | Description |
|---|---|
|  | USB Touch (TYP A) for "USB Touch Cable" |

7.6. Power Connector

Two power connector options:

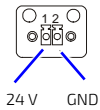
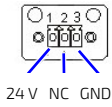
| Power Connector | Description |
|---|--------------------------|
|  | 2-pin, 12 VDC (standard) |
|  | 3-pin, 24 VDC (optional) |

⚠ WARNING

The power connection wires must be clearly marked (+/GND) to ensure proper connection to the power connector and main power supply.

7.7. DP Connector (option)

| DP Connector | Description |
|---|--------------------------------------|
|  | Connector for display port connector |

8/ OSD Control Panel

The On-Screen Display (OSD) is a control panel that enables users to adjust and set viewing options for the Open Frame Monitor as described in Table 11: OSD Screen Icon Functions.

8.1. OSD Control Panel Buttons

Figure 16: OSD Control Panel Buttons

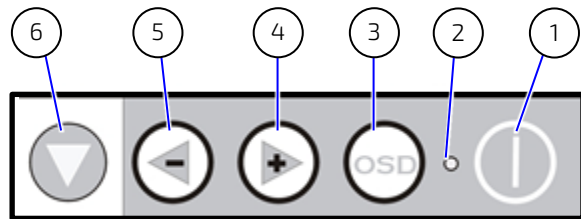

- | | | | |
|---|-----------------|---|--------------------|
| 1 | Power button | 4 | Adjust + |
| 2 | LED | 5 | Adjust - |
| 3 | OSD menu/select | 6 | Auto Adjust select |

Table 10: OSD Control Panel Functions

| Function | Description |
|--------------------|--|
| Power Button | Power button |
| LED | Power indicator LED |
| OSD menu / select | Press to display the OSD menu/press to selects option |
| Adjust + | Increases the selected value |
| Adjust - | Decreases the selected value |
| Auto Adjust select | Automatically adjusts the monitor to the best display efficiency |

8.2. OSD Screen Functions

Pressing the Auto button (Figure 16, Pos. 6) displays the following OSD window status to indicate that the screen is auto adjusting.



If there is no VGA/DVI/DP input signal the following OSD status window appears for 3 seconds indicating that No Cable is connected.

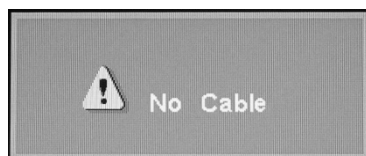

The OSD displays icons for selectable functions as described below.

Table 11: OSD Screen Icon Functions

| Icon | Function | Description |
|---|-------------------------|---|
|  | Brightness | Adjust the Brightness using + and - buttons |
|  | Contrast | Adjust the Contrast using + and - buttons |
|  | Horizontal Position | Adjust the Horizontal Position using + and - buttons (VGA mode only) |
|  | Vertical Position | Adjust the Vertical Position using + and - buttons (VGA mode only) |
|  | Sharpness | Adjust the Sharpness using + and - buttons (VGA mode only) |
|  | OSD Transparency | Adjust the OSD Transparency using + and - buttons |
|  | Phase | Adjust the Phase using + and - buttons (only VGA mode) |
|  | Clock | Adjust the Clock using + and - buttons (only VGA mode) |
|  | Color Temperature | Select the Color Temperature using + and - buttons 6500°K - 7500°K - 9300°K - USER (USER adjust see sub OSD window) |
|  | Horizontal OSD Position | Adjust the Horizontal OSD Position using + and - buttons |
|  | Vertical OSD Position | Adjust the Vertical OSD Position using + and - buttons |
|  | Graphic Text | Graphic : VGA 640\400 Text : VGA 720\400 (Only for VGA 600\400 & VGA720\400 Selection) |
|  | Recall | Select the Recall using + and - buttons Recall factory model |
|  | Language | Select the Language using + and - buttons Supports English, French, Deutsch, Spanish, Italian, Russian, Chinese simplified, Chinese traditional, Japanese. |
|  | Auto Adjust | Select the Auto Adjustment using + and - buttons To be effective, image should be full screen(VGA mode only) |
|  | Exit | Select the Exit using + and - buttons |
|  | Input select | Select the VGA or DVI input using + and - buttons |

8.2.1. OSD Windows- Example Brightness



To use the OSB control panel to change the brightness, perform the following steps:

1. Press "**OSD**" (Figure 16, pos.3) to display the OSD Window.
2. Press the "+" (Figure 16, pos.4) or "-" (Figure 16, pos.5) button to move along the OSD screen icon bar to the "Brightness" icon.
3. Press "**OSD**" (Figure 16, pos.3) to select "Brightness" and move downwards to change the brightness.
4. Press "+" button (Figure 16, pos. 4) to increase the brightness.
5. Press "-" button (Figure 16, pos. 5) to decrease the brightness.
6. Press "**OSD**" (Figure 16, pos.3) to return (one-step backwards) to the OSD screen icon bar.

8.2.2. OSD Window – Example Color Temperature



To use the OSB control panel to change the color temperature, perform the following steps:

1. Press "**OSD**" (Figure 16, pos.3) to display the OSD Window.
2. Press the "+" (Figure 16, pos.4) or "-" (Figure 16, pos.5) button to move along the OSD screen icon bar to the "Color Temperature" icon.
3. Press "**OSD**" (Figure 16, pos.3) to select "Color Temperature" and move downwards to change the RGB values.
4. Press "+" (Figure 16, pos. 4) to increase the Red, Green, Blue value or Press "-" (Figure 16, pos. 5) to decrease the Red, Green, and Blue value.
5. Press the "**Auto Adjust**" downwards arrow to move down (one-step downwards) to the next color.
6. Press "**OSD**" (Figure 16, pos.3) to return (one-step backwards) to the OSD screen icon bar.

9/ Technical Support

9.1. Trouble Shooting

Before contacting Kontron's Support Department, check the following.

Table 12: Trouble Shooting Information

| No image is showing | |
|---|---|
| Is the power cable connected to the monitor? | Check to make sure that the power cable is connected to both the monitor and the power outlet. |
| Is the power LED light next to the power switch on? | Press the power button to switch on the monitor. The LED should be green. |
| Is the power LED orange? | <ul style="list-style-type: none"> ▶ Press Auto Adjust to automatically adjust the display ▶ Check to make sure the video signal cable (VGA/DVI) is properly attached ▶ Check if the graphics card is working normally |
| Is the power on but you still don't have a picture? | Adjust the brightness and contrast. |
| Do you see a "No Signal" message? | If the monitor is on "No Signal" in a short period the device goes into the sleeping mode/ shuts down. |
| Do you see a "No Cable" message? | Connect the video signal cable (VGA/DVI or DP video cable). |
| Display image is incorrect | |
| Display position is incorrect. | Press "Auto Adjust Select" button (Figure 16, pos. 6) to automatically adjust the display to the ideal setting. |
| Vertical bars and stripes appear on the screen. | Press "Auto Adjust Select" button (Figure 16, pos. 6) to automatically adjust the display to the ideal setting. |
| The color of the screen is abnormal. | Check to make sure the signal cable is properly attached. If attached set the color settings in the OSD Control Panel: "Contrast" or "Color Temperature" |
| There is noise on the screen or the pixels don't match. | <ul style="list-style-type: none"> ▶ Press the "AUTO Adjust" (Figure 16, pos. 6) to adjust the display automatically to the ideal setting. ▶ Set manually using the OSD Control Panel (Figure 16) |

9.2. Technical Support

Before delivery, each Open Frame Monitor goes through a defined and recorded testing procedure. Should a problem occur that cannot be solved using the trouble shooting information (see Table 12), contact Kontron's Support during office hours using the following phone number.

- ▶ Phone: +49-37 00 58-314

Make sure you have the following information available when you call:

- ▶ Model
- ▶ Serial Number (SN)



The serial number can be found on the product's type label.

Be ready to explain the nature of your problem to the service technician.

9.3. Returning Defective Merchandise

All equipment returned to Kontron must have a Return of Material Authorization (RMA) number assigned exclusively by Kontron. Kontron cannot be held responsible for any loss or damage caused to the equipment received without an RMA number. The buyer accepts responsibility for all freight charges for the return of goods to Kontron's designated facility. Kontron will pay the return freight charges back to the buyer's location in the event that the equipment is repaired or replaced within the stipulated warranty period. Follow these steps before returning any product to Kontron.

1. Visit the RMA Information website:

<http://www.kontron.com/support-and-services/support/rma-information>

2. Download the RMA Request sheet for Kontron Europe GmbH- Ismaning and fill out the form. Take care to include a short detailed description of the observed problem or failure and to include the product identification Information (Name of product, Product number and Serial number). If a delivery includes more than one product, fill out the above information in the RMA Request form for each product.

Send the completed RMA-Request form to the fax or email address given below at Kontron Europe GmbH. Kontron will provide an RMA-Number.

3. The goods for repair must be packed adequately for shipping, considering shock and ESD protection.



Goods returned to Kontron Europe GmbH in non-proper packaging will be considered as customer caused faults and cannot be accepted as warranty repairs.

4. Include the RMA-Number with the shipping paperwork and send the product to the delivery address provided in the RMA form or received from Kontron RMA Support.

9.4. Warranty

Kontron warrants products in accordance with defined regional warranty periods. For more information about warranty compliance and conformity, and the warranty period in your region, refer to the General Terms and Conditions of Sale document for your region by visiting <http://www.kontron.com/terms-and-conditions>.

Due to their limited service life, parts that by their nature are subject to a particularly high degree of wear (wearing parts) are excluded from the warranty beyond that provided by law.

10/ Storage, Transportation and Maintenance

10.1. Storage

If the product is not in use for an extended time-period, disconnect the power plug from the mains power. If it is necessary to store the product then re-pack the product as originally delivered to avoid damage. The storage facility must meet the products environmental storage requirements as stated within this user guide. Kontron recommends keeping the original packaging material for future storage or warranty shipments.

10.2. Transportation

To ship the product use the original packaging, designed to withstand impact and adequately protect the product. When packing or unpacking products always take shock and ESD protection into consideration and use an EOS/ESD safe working area.

10.3. Maintenance

10.3.1. Cleaning the Display

To clean the display:

- ▶ Gently clean the Open Frame Monitor's display screen with a clean lens brush, or a soft, clean, lint-free cloth, to remove dust and other particles that can scratch the display's screen.
- ▶ Do not apply pressure to the display's surface when wiping the surface clean.
- ▶ Do not pour or spray any liquid directly onto the display's screen or casing. Chemical cleaners may cause damage.

NOTICE

Particles may scratch the surface. Do not apply any pressure.
Use commercially available glass cleaner.

Appendix A: List of Acronyms

Table 13: List of Acronyms (Example)

| | |
|------|---|
| AC | Alternating Current |
| AWG | American Wire Gauge |
| DC | Direct Current |
| DP | Display Port |
| DPMS | Display Power Management Signaling |
| DVI | Digital Video Interface |
| EMC | Electromagnetic Compatibility |
| ESD | Electro Static Device |
| FCC | Federal Communications Commission |
| HDMI | High Definition Multimedia Interface |
| IT | Information technology |
| LCD | Liquid Crystal Device |
| LED | Light Emitting Diode |
| LVD | Low Voltage device |
| MPD | Material Part Number |
| OEM | Original Equipment Manufacturer |
| OSD | On Screen Display |
| PC | Secure Shell |
| RGB | Red, green, Blue |
| RoHS | Restriction Of Hazardous Substances |
| SELV | Safety Extra Low Voltage |
| SN | Serial Number |
| TFT | Thin Film Transistor |
| USB | Universal Serial Bus |
| VESA | Video Electronics Standards Association |
| VGA | Video Graphics Array |
| WEEE | Waste Electrical and Electronic Equipment |

About Kontron

Kontron is a global leader in Embedded Computing Technology (ECT). As a part of technology group S&T, Kontron offers a combined portfolio of secure hardware, middleware and services for Internet of Things (IoT) and Industry 4.0 applications. With its standard products and tailor-made solutions based on highly reliable state-of-the-art embedded technologies, Kontron provides secure and innovative applications for a variety of industries. As a result, customers benefit from accelerated time-to-market, reduced total cost of ownership, product longevity and the best fully integrated applications overall. For more information, please visit: www.kontron.com



Global Headquarters

Kontron S&T AG

Lise-Meitner-Str. 3-5
86156 Augsburg
Germany
Tel.: +49 821 4086-0
Fax: +49 821 4086-111
info@kontron.com