

COMe-bKL6

Doc. User Guide Rev.1.7

Doc. ID: 1061-1954

This page has been intentionally left blank

 COME-BKL6 - USER GUIDE

Disclaimer

Kontron would like to point out that the information contained in this user guide may be subject to alteration, particularly as a result of the constant upgrading of Kontron products. This document does not entail any guarantee on the part of Kontron with respect to technical processes described in the user guide or any product characteristics set out in the user guide. Kontron assumes no responsibility or liability for the use of the described product(s), conveys no license or title under any patent, copyright or mask work rights to these products and makes no representations or warranties that these products are free from patent, copyright or mask work right infringement unless otherwise specified. Applications that are described in this user guide are for illustration purposes only. Kontron makes no representation or warranty that such application will be suitable for the specified use without further testing or modification. Kontron expressly informs the user that this user guide only contains a general description of processes and instructions which may not be applicable in every individual case. In cases of doubt, please contact Kontron.

This user guide is protected by copyright. All rights are reserved by Kontron. No part of this document may be reproduced, transmitted, transcribed, stored in a retrieval system, or translated into any language or computer language, in any form or by any means (electronic, mechanical, photocopying, recording, or otherwise), without the express written permission of Kontron. Kontron points out that the information contained in this user guide is constantly being updated in line with the technical alterations and improvements made by Kontron to the products and thus this user guide only reflects the technical status of the products by Kontron at the time of publishing.

Brand and product names are trademarks or registered trademarks of their respective owners.

©2018 by Kontron Europe GmbH

Kontron Europe GmbH

Gutenbergstraße 2
85737 Ismaning
Germany
www.kontron.com

High Risk Applications Hazard Notice

THIS DEVICE AND ASSOCIATED SOFTWARE ARE NOT DESIGNED, MANUFACTURED OR INTENDED FOR USE OR RESALE FOR THE OPERATION OF NUCLEAR FACILITIES, THE NAVIGATION, CONTROL OR COMMUNICATION SYSTEMS FOR AIRCRAFT OR OTHER TRANSPORTATION, AIR TRAFFIC CONTROL, LIFE SUPPORT OR LIFE SUSTAINING APPLICATIONS, WEAPONS SYSTEMS, OR ANY OTHER APPLICATION IN A HAZARDOUS ENVIRONMENT, OR REQUIRING FAIL-SAFE PERFORMANCE, OR IN WHICH THE FAILURE OF PRODUCTS COULD LEAD DIRECTLY TO DEATH, PERSONAL INJURY, OR SEVERE PHYSICAL OR ENVIRONMENTAL DAMAGE (COLLECTIVELY, "HIGH RISK APPLICATIONS").

You understand and agree that your use of Kontron devices as a component in High Risk Applications is entirely at your risk. To minimize the risks associated with your products and applications, you should provide adequate design and operating safeguards. You are solely responsible for compliance with all legal, regulatory, safety, and security related requirements concerning your products. You are responsible to ensure that your systems (and any Kontron hardware or software components incorporated in your systems) meet all applicable requirements. Unless otherwise stated in the product documentation, the Kontron device is not provided with error-tolerance capabilities and cannot therefore be deemed as being engineered, manufactured or setup to be compliant for implementation or for resale as device in High Risk Applications. All application and safety related information in this document (including application descriptions, suggested safety measures, suggested Kontron products, and other materials) is provided for reference only.

NOTICE

You find the most recent version of the "General Safety Instructions" online in the download area of this product.

NOTICE

This product is not suited for storage or operation in corrosive environments, in particular under exposure to sulfur and chlorine and their compounds. For information on how to harden electronics and mechanics against these stress conditions, contact Kontron Support.

Revision History

Revision	Brief Description of Changes	Date of Issue	Author/ Editor
1.0	Initial version	2017-July-05	CW
1.1	Updated BIOS set up option information in Chapters 3.2.2 and 6.5.1 Updated test Information in Chapter Standards and Certifications	2017-Aug-22	CW
1.2	Updated Kontron to Kontron S&T AG, added a GPIO Chapter and Updated the BIOS Setup information in Advanced menu and Chipset menu	2018-Jan-23	CW
1.3	Included the MTBF graphs	2020-Jan-08	CW
1.4	Added rapid shutdown function information	2020-Jun-29	CW
1.5	Updated Accessories	2020-Jul-23	CW
1.6	Security chip changed to option and new block diagram	2022-Feb-23	CW
1.7	GPIO update Chapter 3.2	2022-Jul-28	CW

Terms and Conditions

Kontron warrants products in accordance with defined regional warranty periods. For more information about warranty compliance and conformity, and the warranty period in your region, visit <http://www.kontron.com/terms-and-conditions>.

Kontron sells products worldwide and declares regional General Terms & Conditions of Sale, and Purchase Order Terms & Conditions. Visit <http://www.kontron.com/terms-and-conditions>.

For contact information, refer to the corporate offices contact information on the last page of this user guide or visit our website [CONTACT US](#).

Customer Support

Find Kontron contacts by visiting: <http://www.kontron.com/support>.

Customer Service

As a trusted technology innovator and global solutions provider, Kontron extends its embedded market strengths into a services portfolio allowing companies to break the barriers of traditional product lifecycles. Proven product expertise coupled with collaborative and highly-experienced support enables Kontron to provide exceptional peace of mind to build and maintain successful products.

For more details on Kontron's service offerings such as: enhanced repair services, extended warranty, Kontron training academy, and more visit <http://www.kontron.com/support-and-services/services>.

Customer Comments

If you have any difficulties using this user guide, discover an error, or just want to provide some feedback, contact [Kontron support](#). Detail any errors you find. We will correct the errors or problems as soon as possible and post the revised user guide on our website.

Symbols

The following symbols may be used in this user guide

⚠ DANGER

DANGER indicates a hazardous situation which, if not avoided, will result in death or serious injury.

⚠ WARNING

WARNING indicates a hazardous situation which, if not avoided, could result in death or serious injury.

NOTICE

NOTICE indicates a property damage message.

⚠ CAUTION

CAUTION indicates a hazardous situation which, if not avoided, may result in minor or moderate injury.



Electric Shock!

This symbol and title warn of hazards due to electrical shocks (> 60 V) when touching products or parts of products. Failure to observe the precautions indicated and/or prescribed by the law may endanger your life/health and/or result in damage to your material.



ESD Sensitive Device!

This symbol and title inform that the electronic boards and their components are sensitive to static electricity. Care must therefore be taken during all handling operations and inspections of this product in order to ensure product integrity at all times.



HOT Surface!

Do NOT touch! Allow to cool before servicing.



Laser!

This symbol inform of the risk of exposure to laser beam and light emitting devices (LEDs) from an electrical device. Eye protection per manufacturer notice shall review before servicing.



This symbol indicates general information about the product and the user guide.

This symbol also indicates detail information about the specific product configuration.



This symbol precedes helpful hints and tips for daily use.

For Your Safety

Your new Kontron product was developed and tested carefully to provide all features necessary to ensure its compliance with electrical safety requirements. It was also designed for a long fault-free life. However, the life expectancy of your product can be drastically reduced by improper treatment during unpacking and installation. Therefore, in the interest of your own safety and of the correct operation of your new Kontron product, you are requested to conform with the following guidelines.

High Voltage Safety Instructions

As a precaution and in case of danger, the power connector must be easily accessible. The power connector is the product's main disconnect device.

⚠ CAUTION

Warning

All operations on this product must be carried out by sufficiently skilled personnel only.

⚠ CAUTION



Electric Shock!

Before installing a non hot-swappable Kontron product into a system always ensure that your mains power is switched off. This also applies to the installation of piggybacks. Serious electrical shock hazards can exist during all installation, repair, and maintenance operations on this product. Therefore, always unplug the power cable and any other cables which provide external voltages before performing any work on this product.

Earth ground connection to vehicle's chassis or a central grounding point shall remain connected. The earth ground cable shall be the last cable to be disconnected or the first cable to be connected when performing installation or removal procedures on this product.

Special Handling and Unpacking Instruction

NOTICE



ESD Sensitive Device!

Electronic boards and their components are sensitive to static electricity. Therefore, care must be taken during all handling operations and inspections of this product, in order to ensure product integrity at all times.

⚠ CAUTION

Handling and operation of the product is permitted only for trained personnel within a work place that is access controlled. Follow the "General Safety Instructions for IT Equipment" supplied with the product.

Do not handle this product out of its protective enclosure while it is not used for operational purposes unless it is otherwise protected.

Whenever possible, unpack or pack this product only at EOS/ESD safe work stations. Where a safe work station is not guaranteed, it is important for the user to be electrically discharged before touching the product with his/her hands or tools. This is most easily done by touching a metal part of your system housing.

It is particularly important to observe standard anti-static precautions when changing piggybacks, ROM devices, jumper settings etc. If the product contains batteries for RTC or memory backup, ensure that the product is not placed on conductive surfaces, including anti-static plastics or sponges. They can cause short circuits and damage the batteries or conductive circuits on the product.

Lithium Battery Precautions

If your product is equipped with a lithium battery, take the following precautions when replacing the battery.

⚠ CAUTION

Danger of explosion if the battery is replaced incorrectly.

- ▶ Replace only with same or equivalent battery type recommended by the manufacturer.
 - ▶ Dispose of used batteries according to the manufacturer's instructions.
-

General Instructions on Usage

In order to maintain Kontron's product warranty, this product must not be altered or modified in any way. Changes or modifications to the product, that are not explicitly approved by Kontron and described in this user guide or received from Kontron Support as a special handling instruction, will void your warranty.

This product should only be installed in or connected to systems that fulfill all necessary technical and specific environmental requirements. This also applies to the operational temperature range of the specific board version that must not be exceeded. If batteries are present, their temperature restrictions must be taken into account.

In performing all necessary installation and application operations, only follow the instructions supplied by the present user guide.

Keep all the original packaging material for future storage or warranty shipments. If it is necessary to store or ship the product then re-pack it in the same manner as it was delivered.

Special care is necessary when handling or unpacking the product. See Special Handling and Unpacking Instruction.

Quality and Environmental Management

Kontron aims to deliver reliable high-end products designed and built for quality, and aims to complying with environmental laws, regulations, and other environmentally oriented requirements. For more information regarding Kontron's quality and environmental responsibilities, visit <http://www.kontron.com/about-kontron/corporate-responsibility/quality-management>.

Disposal and Recycling

Kontron's products are manufactured to satisfy environmental protection requirements where possible. Many of the components used are capable of being recycled. Final disposal of this product after its service life must be accomplished in accordance with applicable country, state, or local laws or regulations.

WEEE Compliance

The Waste Electrical and Electronic Equipment (WEEE) Directive aims to:

- ▶ Reduce waste arising from electrical and electronic equipment (EEE)
- ▶ Make producers of EEE responsible for the environmental impact of their products, especially when the product become waste
- ▶ Encourage separate collection and subsequent treatment, reuse, recovery, recycling and sound environmental disposal of EEE
- ▶ Improve the environmental performance of all those involved during the lifecycle of EEE



Environmental protection is a high priority with Kontron.

Kontron follows the WEEE directive

You are encouraged to return our products for proper disposal.

Table of Contents

Symbols	6
For Your Safety	7
High Voltage Safety Instructions	7
Special Handling and Unpacking Instruction	7
Lithium Battery Precautions	8
General Instructions on Usage	8
Quality and Environmental Management	8
Disposal and Recycling	8
WEEE Compliance	8
Table of Contents	9
List of Tables	11
List of Figures	12
1/ Introduction	13
1.1. Product Description	13
1.2. Product Naming Clarification	13
1.3. COM Express® Documentation	13
1.4. COM Express® Functionality	14
1.5. COM Express® Benefits	14
2/ Product Specification	15
2.1. Module Variants	15
2.1.1. Commercial Grade Modules (0°C to +60°C)	15
2.1.2. Extended Temperature Grade Modules (E1, -25°C to +75°C)	15
2.1.3. Industrial Temperature Grade Modules (E2S, -40°C to +85°C)	16
2.2. Accessories	16
2.3. Functional Specifications	19
2.3.1. Block Diagram COMe-bKL6	19
2.3.2. Processor	20
2.3.3. Platform Controller Hub	21
2.3.4. System Memory	21
2.3.5. Graphics	22
2.3.6. LVDS	22
2.3.7. Audio	23
2.3.8. PCI Express (PCIe) Configuration	23
2.3.9. USB	25
2.3.10. SATA	25
2.3.11. Ethernet	25
2.3.12. COMe High-speed Serial Interfaces Overview	26
2.3.13. Storage Features	27
2.3.14. BIOS/Software Features	27
2.3.15. COMe Features	27
2.3.16. Kontron Features	27
2.4. Electrical Specification	28
2.4.1. Power Supply Voltage Specifications	28
2.4.2. Power Management	28
2.4.3. Power Supply Control Settings	29
2.4.4. Power Supply Modes	29
2.5. Thermal Management	31

2.5.1. Heatspreader and Active or Passive Cooling Solutions	31
2.5.2. Active or Passive Cooling Solutions	31
2.5.3. Operating with Kontron Heatspreader Plate (HSP) Assembly.....	31
2.5.4. Operating without Kontron Heatspreader Plate (HSP) Assembly.....	31
2.5.5. On Board Fan Connector	32
2.6. Environmental Specification.....	33
2.6.1. Temperature.....	33
2.6.2. Humidity	33
2.7. Standards and Certifications	34
2.7.1. MTBF	35
2.8. Mechanical Specification.....	37
2.8.1. Dimensions	37
2.8.2. Height.....	37
2.8.3. Heatspreader Dimensions	38
3/ Features and Interfaces	39
3.1. Fast I2C	39
3.2. GPIO	39
3.3. Intel® Optane™ Memory.....	39
3.4. Kontron Security Solution (optional).....	39
3.5. LPC	39
3.6. Rapid Shutdown.....	40
3.6.1. Crowbar Implementation Details	40
3.6.2. Shutdown Input Circuit Details.....	41
3.7. Real Time Clock (RTC)	41
3.8. Serial Peripheral Interface (SPI).....	42
3.8.1. SPI boot.....	42
3.8.2. Using an External SPI Flash.....	42
3.8.3. External SPI flash on Modules with Intel® ME	43
3.9. SpeedStep® Technology	43
3.10. Trusted Platform Module (TPM 2.0).....	44
3.11. UART	44
3.12. Watchdog Timer (WTD) – Dual Stage.....	44
3.12.1. WDT Signal.....	45
4/ System Resources.....	46
4.1. Interrupt Request (IRQ) Lines	46
4.2. Memory Area	46
4.3. I/O Address Map.....	47
4.4. Peripheral Component Interconnect (PCI) Devices	48
4.5. I2C Bus.....	48
4.6. System Management (SM) Bus	49
5/ COMe Interface Connectors	50
5.1. X1A and X1B Signals	50
5.2. X1A and X1B Pin Assignment.....	51
5.2.1. Connector X1A Row A1 - A110	52
5.2.2. Connector X1A Row B1 - B100	55
5.2.3. Connector X1B Row C1 - C110.....	58
5.2.4. Connector X1B Row D1 - D110.....	61
6/ uEFI BIOS.....	64
6.1. Starting the uEFI BIOS.....	64

6.2. Setup Menus	65
6.2.1. Main Setup Menu	66
6.2.2. Advanced Setup Menu.....	68
6.2.3. Chipset Setup Menu	79
6.2.4. Security Setup Menu.....	89
6.2.5. Boot Setup Menu.....	90
6.2.6. Save and Exit Setup Menu.....	91
6.3. The uEFI Shell.....	93
6.3.1. Basic Operation of the uEFI Shell	93
6.4. uEFI Shell Scripting	94
6.4.1. Startup Scripting.....	94
6.4.2. Create a Startup Script.....	94
6.4.3. Examples of Startup Scripts	94
6.5. Firmware Update.....	95
6.5.1. Updating Procedure.....	95
About Kontron – Member of the S&T Group.....	98

List of Tables

Table 1: Pin Assignment of Type 6 and COMe-bKL6	14
Table 2: Product Number for Commercial Grade Modules (0°C to +60°C operating).....	15
Table 3: Product Number for Industrial Grade Modules including Rapid Shutdown (R E2S, -40°C to +85°C operating).....	16
Table 4: Product Accessories - COMe-bKL6.....	16
Table 5: COMe Type 6 Accessories	16
Table 6: General Accessories.....	17
Table 7: Memory Modules - COMe-bKL6.....	18
Table 8: Processor Specifications.....	20
Table 9: Heatspreader Test Temperature Specifications	31
Table 10: 3-Pin Fan Connector Pin Assignment.....	32
Table 11: Electrical Characteristics of the Fan Connector	32
Table 12: Temperature Grade Specifications	33
Table 13: Humidity Specification.....	33
Table 14: Standards and Certification Compliance	34
Table 15: MTBF Estimated Values	35
Table 16: Supported BIOS Features	40
Table 17: SPI Boot Pin Configuration	42
Table 18: Supported SPI Boot Flash Types for 8-SOIC Package.....	42
Table 19: Dual Stage Watchdog Timer- Time-out Events.....	44
Table 20: Interrupt Requests.....	46
Table 21: Designated Memory Locations.....	46
Table 22: Designated I/O Port Address Ranges	47
Table 23: I2C Bus Port Addresses	48
Table 24: SMBus Addresses	49
Table 25: General Signal Description	51
Table 26: Connector X1A Row A Pin Assignment (A1-A110).....	52
Table 27: Connector X1A Row B Pin Assignment (B1-B110)	55
Table 28: Connector X1B Row C Pin Assignment (C1-C110)	58
Table 29: Connector X1B Row D Pin Assignment (D1-D110)	61
Table 30: Navigation Hot Keys Available in the Legend Bar	64
Table 31: Main Setup Menu Sub-screens	67
Table 32: Advanced Setup menu Sub-screens and Functions.....	68
Table 33: Chipset Set > System Agent Configuration Sub-screens and Functions	79
Table 34: Chipset Set > PCH-IO Configuration Sub-screens and Functions	83

Table 35: Security Setup Menu Functions.....	89
Table 36: Boot Setup Menu Functions.....	90
Table 37: Save and Exit Setup Menu Functions.....	91
Table 38: List of Acronyms.....	96

List of Figures

Figure 1: COMe-bKL6 Functional Block Diagram.....	19
Figure 2: MTBF De-rating Values @ 40°C for the COMe-bKL6 i3-7102E CM238 (MTBF: 598847 hours).....	35
Figure 3: MTBF De-rating Values @ 40°C for the COMe-bKL6 E2S E3-1505M CM238 (MTBF: 542327 hours).....	36
Figure 4: Module Dimensions.....	37
Figure 5: Module Height	37
Figure 6: Heatspreader Location and Dimensions	38
Figure 7: X1A and X1B COMe Interface Connectors.....	50
Figure 8: Main Setup Menu Initial Screens.....	66
Figure 9: Advanced Setup Menu Initial Screen	68
Figure 10: System Agent Configuration Menu Initial Screen.....	79
Figure 11: PCH-IO Configuration Menu Initial Screen	83
Figure 12: Security Setup Menu Initial Screen	89
Figure 13: Boot Setup Menu Initial Screen.....	90
Figure 14: Save and Exit Setup Menu Initial Screen.....	91

1/ Introduction

1.1. Product Description

The COMe-bKL6 is a basic form factor COM Express® type 6 Computer-On-Module based on the Intel® 7th Generation Core™ series family of processors, known as Kaby Lake-H within this user guide. The COMe-bKL6 supports additional communication interfaces via a separate chipset Intel's® mobile (CM238 or QM175). The Kaby Lake-H combines increased efficiency and performance with TDP as low as 25 W, and no more than 45 W, with Intel's® HD Graphics Gen9 capabilities.

Basic COMe-bKL6 features are:

- ▶ Intel® 7th Generation Core™ series, Kaby Lake-H family with CM238/QM175
- ▶ Up to 32 GByte with 2 x DDR4-2400 SO-DIMM (non-ECC/ECC)
- ▶ High-speed connectivity 8x PCIe x1, 1x PEG x16, 1x 1 Gb Ethernet, 4x USB 3.0 (incl. USB 2.0) + 4x USB 2.0
- ▶ Support for both commercial and Industrial temperature grade environments

1.2. Product Naming Clarification

COM Express® defines a Computer-On-Module, or COM, with all the components necessary for a bootable host computer, packaged as a super component. The product names for Kontron COM Express® Computer-on-Modules consist of:

- ▶ Short form of the industry standard
 - ▶ COMe-
- ▶ Module form factor
 - ▶ b=basic (125mm x 95mm)
 - ▶ c=compact (95mm x 95mm)
 - ▶ m=mini (84mm x 55mm)
- ▶ Intel's® processor code name
 - ▶ KL = Kaby Lake
- ▶ Pinout type
 - ▶ Type 6
 - ▶ Type10
- ▶ Available temperature variants
 - ▶ Commercial
 - ▶ Extended (E1)
 - ▶ Industrial (E2)
 - ▶ Screened industrial (E2S) and Rapid shutdown screened industrial (R E2S)
- ▶ Processor Identifier
- ▶ Chipset identifier (if chipset assembled)
- ▶ Memory size
 - ▶ Memory module (#G) / eMMC SLC memory (#S)

1.3. COM Express® Documentation

The COM Express® specification defines the COM Express® module form factor, pinout and signals. The COM Express document is available on the PICMG® website.

1.4. COM Express® Functionality

All Kontron COM Express® basic and compact modules contain two 220-pin connectors. Each connector has two rows called Row A & B on the primary connector and Row C & D on the secondary connector. COM Express® Computer-On-Modules feature the following maximum amount of interfaces according to the PICMG module pinout type.

Table 1: Pin Assignment of Type 6 and COMe-bKL6

Feature	Type 6 Pinout	COMe-bKL6 Pinout
HD Audio	1x	1x
Gbit Ethernet	1x	1x
Serial ATA	4x	4x
PCI Express x 1	8x	8x
PCI Express x16 (PEG)	1x	1x
USB Client	1x (optional)	1x (optional)
USB	4x USB 3.0 (Incl. USB 2.0) + 4x USB 2.0	4x USB 3.0 (Incl. USB 2.0) + 4x USB 2.0
VGA	1x	1x optional DP to VGA converter
LVDS (eDP)	Dual Channel	Dual Channel LVDS with option to overlay (eDP)
DP++ (DP/HDMI/DVI)	3x	3x
LPC	1x	1x
External SMB	1x	1x
External I2C	1x	1x
GPIO	8x	8x
SDIO shared w/GPIO		
UART (2-wire COM)	2x	2x
FAN PWM out	1x	1x

1.5. COM Express® Benefits

COM Express® defines a Computer-On-Module, or COM, with all the components necessary for a bootable host computer, packaged as a highly integrated computer. All Kontron COM Express® modules are very compact and feature a standardized form factor and a standardized connector layout that carry a specified set of signals. Each COM is based on the COM Express® specification. This standardization allows designers to create a single-system baseboard that can accept present and future COM Express® modules.

The baseboard designer can optimize exactly how each of these functions implements physically. Designers can place connectors precisely where needed for the application, on a baseboard optimally designed to fit a system's packaging.

A single baseboard design can use a range of COM Express® modules with different sizes and pinouts. This flexibility differentiates products at various price and performance points and provides a built-in upgrade path when designing future-proof systems. The modularity of a COM Express® solution also ensures against obsolescence when computer technology evolves. A properly designed COM Express® baseboard can work with several successive generations of COM Express® modules.

A COM Express® baseboard design has many advantages of a customized computer-board design and, additionally, delivers better obsolescence protection, heavily reduced engineering effort, and faster time to market.

2/ Product Specification

2.1. Module Variants

The COMe-bKL6 is available in different processor, chipset and temperature variants to cover demands in performance, price and power.

2.1.1. Commercial Grade Modules (0°C to +60°C)

Table 2: Product Number for Commercial Grade Modules (0°C to +60°C operating)

Product Number	Product Name	Description
38032-0000-30-4	COMe-bKL6 E3-1505M CM238	COM Express® basic pin-out type 6 Computer-on-Module with Intel® Xeon® E3-1505M v6, 4x3.0GHz, CM238 PCH, GT2, 2x DDR4 non-ECC/ECC SO-DIMM
38032-0000-22-4	COMe-bKL6 E3-1505L CM238	COM Express® basic pin-out type 6 Computer-on-Module with Intel® Xeon® E3-1505L v6, 4x2.2GHz, CM238 PCH, GT2, 2x DDR4 non-ECC/ECC SO-DIMM
38032-0000-30-7	COMe-bKL6 i7-7820EQ QM175	COM Express® basic pin-out type 6 Computer-on-Module with Intel® Core™ i7-7820EQ, 4x3.0GHz, QM175 PCH, GT2, 2x DDR4 non-ECC SO-DIMM
38032-0000-29-5	COMe-bKL6 i5-7440EQ QM175	COM Express® basic pin-out type 6 Computer-on-Module with Intel® Core™ i5-7440EQ, 4x2.9GHz, QM175 PCH, GT2, 2x DDR4 non-ECC SO-DIMM
38032-0000-21-5	COMe-bKL6 i5-7442EQ QM175	COM Express® basic pin-out type 6 Computer-on-Module with Intel® Core™ i5-7442EQ, 4x2.1GHz, QM175 PCH, GT2, 2x DDR4 non-ECC SO-DIMM
38032-0000-29-3	COMe-bKL6 i3-7100E CM238	COM Express® basic pin-out type 6 Computer-on-Module with Intel® Core™ i3-7100E, 2x2.9 GHz, CM238 PCH, GT2, 2x DDR4 non-ECC/ECC SO-DIMM
38032-0000-21-3	COMe-bKL6 i3-7102E CM238	COM Express® basic pin-out type 6 Computer-on-Module with Intel® Core™ i3-7102E, 2x2.1 GHz, CM238 PCH, GT2, 2x DDR4 non-ECC/ECC SO-DIMM

2.1.2. Extended Temperature Grade Modules (E1, -25°C to +75°C)

Extended temperature grade modules (E1, -25°C to +75°C) are available as a standard product number, on request. Contact your local sales representative to find out more about available extended temperature variants.

2.1.3. Industrial Temperature Grade Modules (E2S, -40°C to +85°C)

Industrial temperature grade modules (E2S, -40°C to +85 °C) are available as a project based custom product number. For further information, contact your local sales representative. Alternatively, consider using the R E2S variants.

2.1.3.1. Rapid Shutdown Industrial Temperature Grade Modules (R E2S, -40°C to +85°C)

The following table lists R E2S modules available with Kontron Rapid Shutdown support and E2 industrial temperature grade (-40°C to +85°C) by screening.



For Further information regarding the screening process, contact Kontron Support.

Table 3: Product Number for Industrial Grade Modules including Rapid Shutdown (R E2S, -40°C to +85°C operating)

Product Number	Product Name	Description
38033-0000-30-4	COMe-bKL6R E2S E3-1505M CM238	COM Express® basic pin-out type 6 Computer-on-Module with Intel® Xeon® E3-1505M v6, 4x3.0GHz, CM238 PCH, GT2, 2x DDR4 non-ECC/ECC SO-DIMM, Rapid Shutdown, industrial temperature grade
38033-0000-22-4	COMe-bKL6R E2S E3-1505L CM238	COM Express® basic pin-out type 6 Computer-on-Module with Intel® Xeon® E3-1505L v6, 4x2.2GHz, CM238 PCH, GT2, 2x DDR4 non-ECC/ECC SO-DIMM, Rapid Shutdown, industrial temperature grade
38033-0000-29-3	COMe-bKL6R E2S i3-7100E CM238	COM Express® basic pin-out type 6 Computer-on-Module with Intel® Core™ i3-7100E, 2x2.9 GHz, CM238 PCH, GT2, 2x DDR4 non-ECC/ECC SO-DIMM, Rapid Shutdown, industrial temperature grade
38033-0000-21-3	COMe-bKL6R E2S i3-7102E CM238	COM Express® basic pin-out type 6 Computer-on-Module with Intel® Core™ i3-7102E, 2x2.1 GHz, CM238 PCH, GT2, 2x DDR4 non-ECC/ECC SO-DIMM, Rapid Shutdown, industrial temperature grade

2.2. Accessories

Accessories are either COMe-bKL6 product specific, type 6 COMe pinout specific, or general accessories including memory modules. For more information, contact your local Kontron sales representative or Kontron Inside Sales.

Table 4: Product Accessories - COMe-bKL6

Part Number	Heatspreader	Description
38030-0000-99-0	HSP COMe-bSL6/bKL6 Cu-core threaded	For all CPUs and temperature grades
38030-0000-99-1	HSP COMe-bSL6/bKL6 Cu-core through	For all CPUs and temperature grades

Table 5: COMe Type 6 Accessories

Part Number	COMe Carrier	Project Code	Description
38115-0000-00-x	COM Express® Reference Carrier-i Type 6	ADT1	Thin-mITX Carrier with 5 mm COMe connector
38116-0000-00-5	COM Express® Eval Carrier2 Type 6	ADT6	ATX Carrier with 5 mm COMe connector

Part Number	COMe Adapter / Card	Project Code	Description
96007-0000-00-3	ADA-PCIe-DP	APDP	PCIe x16 to DP Adapter for Evaluation Carrier
96007-0000-00-7	ADA-Type6-DP3	DVO6	(Sandwich) Adapter Card for 3x DisplayPort
96006-0000-00-2	COMe POST T6	NFCB	POST Code / Debug Card
38019-0000-00-0	ADA-COMe-Height-dual	EERC	Height Adapter

Table 6: General Accessories

Part Number	Cooling Solutions	Description
38025-0000-99-0C05	HSK COMe-bHL6/bBL6/bSL6/bKL6 active (w/o HSP)	For all CPUs and commercial temperature grade usage, to be mounted on HSP
38025-0000-99-0C06	HSK COMe-bHL6/bBL6/bSL6/bKL6 passive (w/o HSP)	For all CPUs and commercial temperature grade usage, to be mounted on HSP
Part Number	Mounting	Description
38017-0000-00-5	COMe Mount KIT 5 mm 1 set	Mounting Kit for 1 module including screws for 5 mm connectors
38017-0100-00-5	COMe Mount KIT 5 mm 100 sets	Mounting Kit for 100 modules including screws for 5 mm connectors
38017-0000-00-0	COMe Mount KIT 8 mm 1 set	Mounting Kit for 1 module including screws for 8 mm connectors
38017-0100-00-0	COMe Mount KIT 8 mm 100 sets	Mounting Kit for 100 modules including screws for 8 mm connectors
Part Number	Display Adapter	Description
96006-0000-00-8	ADA-DP-LVDS	DP to LVDS adapter
96082-0000-00-0	KAB-ADAPT-DP-DVI	DP to DVI adapter cable
96083-0000-00-0	KAB-ADAPT-DP-VGA	DP to VGA adapter cable
96084-0000-00-0	KAB-ADAPT-DP-HDMI	DP to HDMI adapter cable
Part Number	Cables	Description
96079-0000-00-0	KAB-HSP 200mm	Cable adapter to connect fan to module (COMe basic/compact)
96079-0000-00-2	KAB-HSP 40 mm	Cable adapter to connect fan to module (COMe basic/compact)

Table 7: Memory Modules - COMe-bKL6

Part Number	Memory (validated reference types)	
97017-4096-24-0	DDR4-2400 SODIMM 4 GB_COM	DDR4-2400, 4GB, 260P, 1200MHz, PC4-2400 SO-DIMM
97017-8192-24-0	DDR4-2400 SODIMM 8 GB_COM	DDR4-2400, 8GB, 260P, 1200MHz, PC4-2400 SO-DIMM
97017-1600-24-0	DDR4-2400 SODIMM 16 GB_COM	DDR4-2400, 16GB, 260P, 1200MHz, PC4-2400 SO-DIMM
97017-4096-24-2	DDR4-2400 SODIMM 4 GB E2_COM	DDR4-2400, 4GB, E2, 260P, 1200MHz, PC4-2400 SO-DIMM
97017-8192-24-2	DDR4-2400 SODIMM 8 GB E2_COM	DDR4-2400, 8GB, E2, 260P, 1200MHz, PC4-2400 SO-DIMM
97017-1600-24-2	DDR4-2400 SODIMM 16 GB E2_COM	DDR4-2400, 16GB, E2, 260P, 1200MHz, PC4-2400 SODIMM
Part Number	Memory ECC (validated reference types)	
97018-4096-24-0	DDR4-2400 SODIMM 4 GB ECC_COM	DDR4-2400, 4GB, ECC, 260P, 1200MHz, PC4-2400 SO-DIMM
97018-8192-24-0	DDR4-2400 SODIMM 8 GB ECC_COM	DDR4-2400, 8GB, ECC, 260P, 1200MHz, PC4-2400 SO-DIMM
97018-1600-24-0	DDR4-2400 SODIMM 16 GB ECC_COM	DDR4-2400, 16GB, ECC, 260P, 1200MHz, PC4-2400 SO-DIMM
97018-4096-24-2	DDR4-2400 SODIMM 4 GB ECC E2_COM	DDR4-2400, 4GB, ECC, E2, 260P, 1200MHz, PC4-2400 SO-DIMM
97018-8192-24-2	DDR4-2400 SODIMM 8 GB ECC E2_COM	DDR4-2400, 8GB, ECC, E2, 260P, 1200MHz, PC4-2400 SO-DIMM
97018-1600-24-2	DDR4-2400 SODIMM 16 GB ECC E2_COM	DDR4-2400, 16GB, ECC, E2, 260P, 1200MHz, PC4-2400 SO-DIMM

2.3. Functional Specifications

2.3.1. Block Diagram COMe-bKL6

The following figure displays the system block diagram applicable to all COMe-bKL6 modules.

Figure 1: COMe-bKL6 Functional Block Diagram

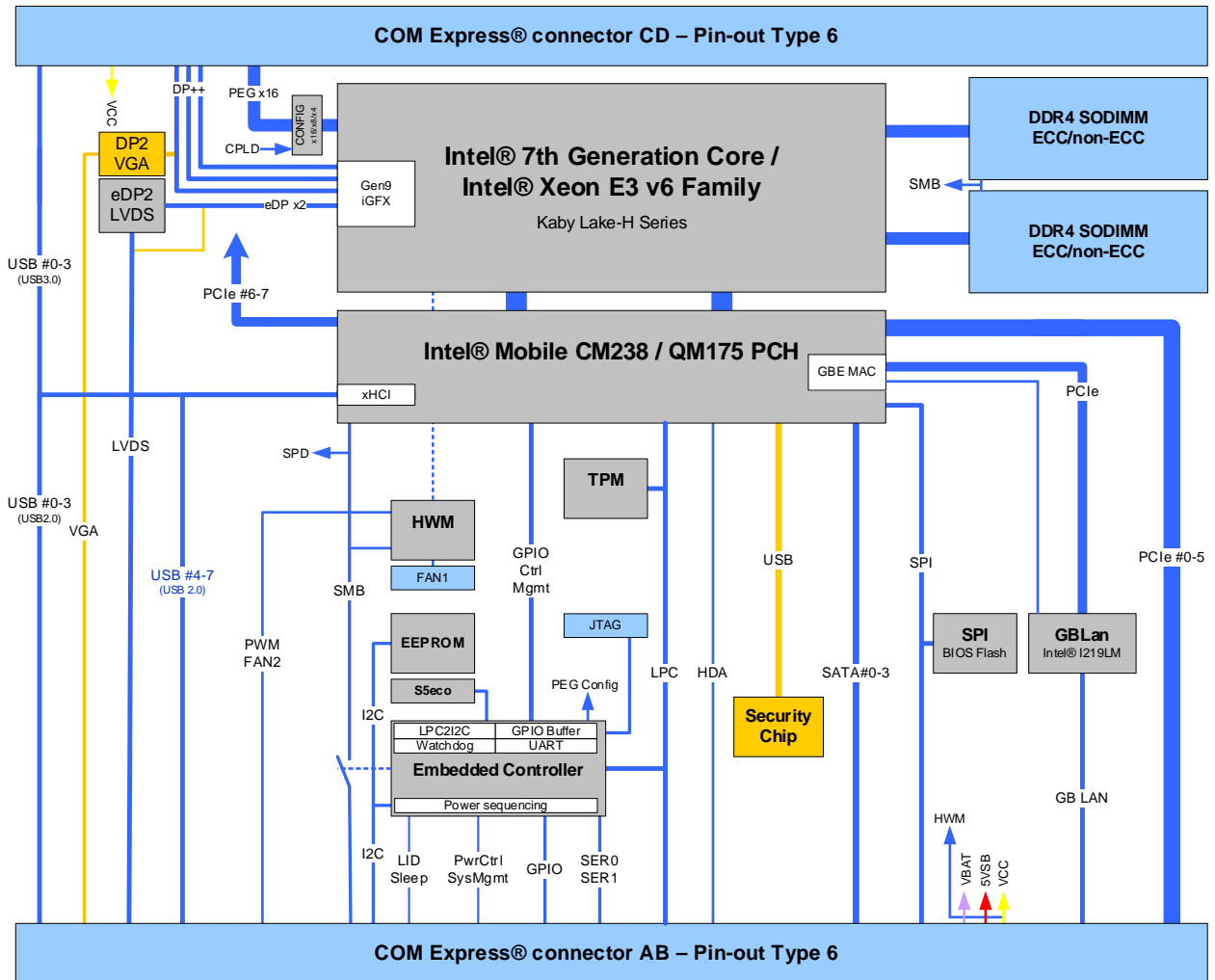

2.3.2. Processor

The Intel® 7th Generation Kaby Lake – H product series of Intel® Xeon® and Core™ processors uses the 14 nm processor technology with 42 mm x 28 mm package size and BGA 1440.

General processor specifications shared by the Intel® Core™ and Celeron® processor variants are:

- ▶ Intel® 64 Architecture
- ▶ Idle States
- ▶ Intel® Virtualization Technology (VT-x)
- ▶ Virtualization Technology for Directed I/O (VT-d)
- ▶ Enhanced Intel Speedstep® Technology
- ▶ Thermal Monitoring Technology
- ▶ Intel® AES New Instructions (AES-NI)
- ▶ OS Guard
- ▶ Execute Disable Bit

The following table lists the general Intel® Xeon® and Core™ Kaby Lake- H processor specifications.



Not all the items specified in Table 8: Processor Specifications are compatible with the COMe-bKL6 functional specification. For more information on features supported by the COMe-bKL6, see the relevant subheading in Chapter 2.3 Functional Specifications.

Table 8: Processor Specifications

Intel®	Xeon®	Xeon®	Core™	Core™	Core™	Core™	Core™
Kaby lake-H Processor	E3-1505L v6	E3-1505M v6	i7 – 7820EQ	i5- 7442EQ	i5- 7440EQ	i3- 7100E	i3- 7102E
# of Cores	4	4	4	4	4	2	2
# of Threads	8	8	8	4	4	4	4
Processor Base Frequency	2.2 GHz	3 GHz	3 GHz	2.1 GHz	2.9 GHz	2.9 GHz	2.1 GHz
Max Turbo Frequency	3 GHz	4 GHz	3.7 GHz	2.9 GHz	3.6 GHz	2.9 GHz	2.1 GHz
Thermal Design Power (TDP)	25 W	45 W	45 W	25 W	45 W	35 W	25 W
TDP down		35 W	35 W		35 W		
Cache	8 MB	8 MB	8 MB	6 MB	6 MB	3 MB	3 MB
Memory Types	DDR4-2400	DDR4-2400 LPDDR-2133 DDR3L-1600	DDR4-2400	DDR4-2400	DDR4-2400	DDR4-2400	DDR4-2400
Max.# Mem. Channels	2	2	2	2	2	2	2
Max. Memory Size	64 GB	64 GB	64 GB	64 GB	64 GB	64 GB	64 GB

Intel® Kaby lake-H Processor	Xeon®	Xeon®	Core™	Core™	Core™	Core™	Core™
	E3-1505L v6	E3-1505M v6	i7 – 7820EQ	i5- 7442EQ	i5- 7440EQ	i3- 7100E	i3- 7102E
Max. Memory Bandwidth	34.1 GB/s	34.1 GB/s	34.1 GB/s	34.1 GB/s	34.1 GB/s	34.1 GB/s	34.1 GB/s
ECC Memory	Supported	Supported	Not supported	Not supported	Not supported	Supported	Supported
HD Graphics	HD Graphic P630	HD Graphics P630	HD Graphics 630	HD Graphics 630	HD Graphics 630	HD Graphics 630	HD Graphics 630
PCIe Express Configuration	1x16, 2x8, 1x8+2x4	1x16, 2x8, 1x8+2x4	1x16, 2x8, 1x8+2x4	1x16, 2x8, 1x8+2x4	1x16, 2x8, 1x8+2x4	1x16, 2x8, 1x8+2x4	1x16, 2x8, 1x8+2x4
Max. # PCIe Lanes	16	16	16	16	16	16	16

2.3.3. Platform Controller Hub

The Kaby Lake –H series of processors is a two-chip solution implementing either the mobile Intel® CM238 chipset or mobile Intel® QM175 chipset, for the Platform Controller Hub (PCH). Which chipset is implemented depends on the temperature grade and processor variant:

- ▶ Intel® QM175 (Commercial temperature grades for all Core™ i5, Core™ i7 processor variants)
- ▶ Intel® CM238 (Commercial temperature grades for all Core™ i3, Xeon® E3 processor variants)
- ▶ Intel® CM238 (Industrial temperature grades for all processor variants)

The following table lists the specific PCH features.

Intel® Optane™	Supported
Rapid Storage Technology (RST)	Supported
USB	4x USB 3.0 (Incl. USB 2.0) 4x USB 2.0
VT-d	Supported
SATA RAID	Supported

2.3.4. System Memory

The system memory supports two memory channels with DDR4-2400 SO-DIMM sockets for up a maximum of up to 32 GByte (2x 16 GByte) of non ECC/ECC memory modules.

The following table lists the specific system memory features.

Socket	2x DDR4-2400 SO-DIMM
Memory Type	Channel 1: DDR4-2400 SO-DIMM up to 16 GB Channel 2: DDR4-2400 SO-DIMM up to 16 GB
Memory Module Size	4 GBytes, 8 GByte and 16 GByte
Bandwidth	34.1 GB/s at 2400 MT/s

In general, memory modules have a much lower longevity than embedded motherboards, and therefore the EOL of the memory modules may occur several times during the lifetime of the motherboard. Kontron guarantees to maintain memory modules by replacing EOL memory modules with another qualified similar module.

As a minimum, it is recommend to use Kontron memory modules for prototype system(s) in order to prove the stability of the system and as a reference.

For volume production, if required, test and qualify other types of RAM. In order to qualify RAM it is recommend to configure three systems running a RAM Stress Test program in a heat chamber at 60°C, for a minimum of 24 hours.



For a list of Kontron memory modules, see Table 7: Memory Modules.

2.3.5. Graphics

2.3.5.1. Digital Display Interface

Up to three independent Digital Display Interfaces (DDIs) including (eDP) can be used simultaneously and in combination, to implement an independent or cloned display configuration. A VGA option is available that utilizes DDI3.

The standard DDIs are:

- ▶ 3x DP 1.2 (++) on DDI1, DDI2 and DDI3
- ▶ 1x eDP 1.4/LVDS on DDI0
- ▶ Optional VGA – Display port to VGA converter (DP2VGA) on DDI3

2.3.5.2. Display Resolution

The following table lists the maximum display resolutions at a set frequency and bit per pixel (bpp) for the supported display interfaces.

Display Interfaces	Maximum Resolution
eDP	4096 x 2304 (60 Hz, 24 bpp)
DP+	4096 x 2304 (60 Hz, 24 bpp)
HDMI 1.4 (native)	4096 x 2160 (24 Hz, 24 bpp)
HDMI 2.0 (via LS-Pcon)	4096 x 2160 (60 Hz, 24 bpp)
VGA	1920 x 1200 (60 Hz, 24 bpp)



At 4K/UHD resolution, a DisplayPort redriver on the carrier is recommended to increase the link margin.

2.3.6. LVDS

The embedded display port to LVDS bridge (eDP2LVDS) supports dual LVDS 18-bit or 24-bit.channels.

The following table lists the basic LVDS features.

LVDS Channels	2x
LVDS Bits / Pixel	18-bit; 24-bit
LVDS Maximum Resolution	Up to 1920 x 1200
PWM Backlight Control	I2C/PWM backlight support
Supported Panel Data	JILI; EDID, VESA DID

2.3.7. Audio

Three independent HD Audio streams can be supported simultaneously on HDMI and DP. The default for audio support is over the Display Port (DP), with an additional option for baseboard audio via an external HDA codec on the carrier board.

2.3.8. PCI Express (PCIe) Configuration

The COMe-bKL6 supports eight general-purpose PCI Express lanes and one PCI Express Graphic (PEG) port with 16 lanes.

2.3.8.1. General-Purpose PCI-Express Lanes [0-7]

The COMe connector supports eight general-purpose PCIe lanes [PCIE0-PCIE7]. The COMe signals [PCIE0-PCIE3] serve as an additional Intel PCIe Storage Device #1.

The following table lists the supported general-purpose PCI-Express lanes.

COMe Lane	PSH High-speed I/O Port #	PCH I/O Function	Comment
PCIE0	15	PCIe #9	Also serves as an Intel® PCIe Storage Device #1
PCIE1	16	PCIe #10	
PCIE2	17	PCIe #11	
PCIE3	18	PCIe #12	
PCIE4	7	PCIe #1	
PCIE5	8	PCIe #2	
PCIE6	9	PCIe #3	
PCIE7	10	PCIe #4	

2.3.8.2. PCI-Express Graphics x16 (PEG) Port

One PCI Express Graphics x16 (PEG) port is available on the COMe connector. The PEG port's default configuration is 1x16 non-reversed with additional configuration options 1x16, 2x8, and 1x8+2x4 in both non-reversed and reversed directions. The configuration can be changed in the BIOS setup.

If more than one device is connected then the device with the highest lane count should be connected to the lower lanes. For example, connect PEG lane 0 to lane 0 of the device with the highest lane count. For lane reversal, the opposite is true. In this case, connect the device with the highest lane count to the higher lanes. For example, connect PEG lane 15 to lane 0 of the device.

The following table lists the PCI-Express Graphics x16 (PEG) port bifurcation and non-reversed lane mapping options.

COMe PEG	(1 x16) Non-Reversed		(2x8) Non-Reversed		(1x8 + 2x4) Non-Reversed	
Lane 0	0	Linked with [0:1:0]	0	Linked with [0:1:0]	0	Linked with [0:1:0]
Lane 1	1	[Segment:Bus:Device]	1	[Segment:Bus:Device]	1	[Segment:Bus:Device]
Lane 2	2		2		2	
Lane 3	3		3		3	
Lane 4	4		4		4	
Lane 5	5		5		5	
Lane 6	6		6		6	
Lane 7	7		7		7	
Lane 8	8		0	Linked with [0:1:1]	0	Linked with [0:1:1]
Lane 9	9		1	[Segment:Bus:Device]	1	[Segment:Bus:Device]
Lane 10	10		2		2	
Lane 11	11		3		3	
Lane 12	12		4		0	Linked with [0:1:2]
Lane 13	13		5		1	[Segment:Bus:Device]
Lane 14	14		6		2	
Lane 15	15		7		3	

The following table lists the PCI-Express Graphics x16 (PEG) port bifurcation and reversed lane mapping options.

COMe PEG	(1 x16) Reversed		(2x8) Reversed		(1x8 + 2x4) Reversed		
Lane 0	15	Linked with 0:1:0	7	Linked with 0:1:1	3	Linked with 0:1:2	
Lane 1	14	[Segment:Bus:Device]	6	[Segment:Bus:Device]	2	[Segment:Bus:Device]	
Lane 2	13		5		1		
Lane 3	12		4		0		
Lane 4	11		3		3		Linked with 0:1:1
Lane 5	10		2		2		[Segment:Bus:Device]
Lane 6	9		1		1		
Lane 7	8		0		0		
Lane 8	7		7	Linked with 0:1:0	7	Linked with 0:1:0	
Lane 9	6		6	[Segment:Bus:Device]	6	[Segment:Bus:Device]	
Lane 10	5		5		5		
Lane 11	4		4		4		
Lane 12	3		3		3		
Lane 13	2		2		2		
Lane 14	1		1		1		
Lane 15	0		0		0		

2.3.9. USB

Both USB 3.0 ports and USB 2.0 ports are available, where USB 3.0 ports are backwards compatible with the USB 2.0 specification.

The following table lists the supported USB features.

USB Ports	4x USB 3.0 (Including USB 2.0) 4x USB 2.0
USB Over Current Signals	4x
USB Client Port	1x (optional for all COMe-types)

The following table lists the COMe connector port and PCH port USB 3.0 and USB 2.0 port combinations.

COMe Port	USB 3.0 (PCH Port)	USB 2.0 (PCH Port)	Comments
USB0	USB3_1	USB2_1	SuperSpeed USB 3.0 or USB 2.0
USB1	USB3_2	USB2_2	
USB2	USB3_3	USB2_3	
USB3	USB3_4	USB2_4	
USB4		USB2_5	USB 2.0 exclusive
USB5		USB2_6	
USB6		USB2_7	
USB7		USB2_8	

2.3.10. SATA

The SATA high-speed storage interface supports four SATA Gen3 ports with transfer rates of up to 6 Gb/s. The following SATA ports are available at the following COMe connector ports.

The following table lists the COMe connector port and PCH port SATA combinations.

COMe Port	PCH High-speed I/O Port #	PCH I/O Function	Comments
SATA0	19	SATA #0B	SATA Gen3, 6Gb/s
SATA1	20	SATA #1B	SATA Gen3, 6Gb/s
SATA2	21	SATA #2	SATA Gen3, 6Gb/s
SATA3	22	SATA #3	SATA Gen3, 6Gb/s

2.3.11. Ethernet

Ethernet connectivity is achieved via a single-port integrated physical layer (PHY) supporting Ethernet Media Dependent Interfaces [0-3]. One 10/100/1000 Mbit Ethernet LAN port is available on high-speed I/O port 11.

The following table lists the supported Ethernet features.

Ethernet	10 Base-T/100 Base-TX and 1000 Base-T
Ethernet Controller	Intel® i219LM

Additional features of the Ethernet controller are:

- ▶ Intel® vPRO™
- ▶ Energy Efficient Ethernet (IEEE 802.3az)
- ▶ Intel® SIPP Server Operating System Support
- ▶ Jumbo frames (up to 9 kB)
- ▶ Reduced power consumption during normal operation
- ▶ Integrated Intel® Auto Connect Battery Saver (ACBS)



If the LAN-Cable is disconnected, the ULP (Ultra Low Power) driver featured in Windows 10 can cause undefined LED behavior. To disable ULP use the "Intel ULPenable-Utility 1.3". For more information refer to the EMD Customer Section or contact Kontron Support.

2.3.12. COMe High-speed Serial Interfaces Overview

The following table provides an overview of the COMe connector's PCH high-speed serial interface ports.

COMe Port	PCH High-speed I/O Port #	USB 3.0	PCIe 3.0	SATA 3.0	LAN	Comments
SATA3	22			SATA#3		SATA Gen3 (6Gb/s)
SATA2	21			SATA #2		
SATA1	20			SATA #1B		
SATA0	19			SATA #0B		
PCIE3	18		PCIe #12			PCI Express lane [0-15] Also serves as an Intel® PCIe storage device #1
PCIE2	17		PCIe #11			
PCIE1	16		PCIe #10			
PCIE0	15		PCIe #9			
GBE-MDI	11				1 GbE	10/100/1000 Mbit Ethernet
PCIE7	10		PCIe #4			PCI Express lane [0-15]
PCIE6	9		PCIe #3			
PCIE5	8		PCIe #2			
PCIE4	7		PCIe #1			
USB3	4	USB3_4				SuperSpeed USB 3.0
USB3	3	USB3_3				
USB1	2	USB3_2				
USB0	1	USB3_1				

2.3.13. Storage Features

The following table lists the supported storage features.

Serial-ATA	4x SATA Gen3 6Gb/s
SATA AHCI	NCQ, HotPlug, Staggered Spinup, eSATA, PortMultiplier

2.3.14. BIOS/Software Features

The following table lists the supported BIOS and software features.

BIOS EFI	AMI Aptio V UEFI
Software	KeAPI 3.0 for all supported OS EFI Utilities to log and process module information BIOS/EFI Flash utility for EFI Shell, Windows, Linux BIOS/EFI utility for customers to implement Boot Logo
Operating System (OS)	Windows 10 (64 bit) Linux 64 bit + LiveCD VxWorks 7.x (64 bit)

2.3.15. COMe Features

The following table lists the supported COM Express® features.

SPI	Boot from an external SPI
LPC	Supported
UART	2x UART (RX/TX)
LID Signals	Supported
Sleep Signals	Supported
Audio	HD Audio for external HDA codecs
SMBus	Speed configurable, default 100 k SMB

2.3.16. Kontron Features

The following table lists the supported Kontron specific product features.

External I2C Bus	Fast I2C, Multimaster capable
Embedded API	KeAPI 3.0 for all supported OS
Customer BIOS Settings / Flash Backup	Supported
Watchdog Support	Dual staged
External SIO	Supported on the base board
GPIO	Start-up level configurable, GPI interrupt capable
Rapid Shutdown	Supported on dedicated variants

2.4. Electrical Specification

2.4.1. Power Supply Voltage Specifications

The COMe-bKL6 supports operation in both single power supply mode and ATX power supply mode.



**Industrial temperature grade modules are validated for 12 V power supply only.
Commercial temperature grade modules support the wide range 8.5 V to 20 V power supply.**

The following table lists the power supply specifications.

Supply Voltage Range (VCC)	8.5 V – 20 V
Supply Voltage (VCC)	12 V
Standby Voltage	5 V ± 5% (5 VSB is not mandatory for operation)
RTC	2.8 V to 3.47 V

2.4.1.1. Power Supply Rise Time

The input voltage rise time is 0.1 ms to 20 ms from input voltage $\leq 10\%$ to nominal VCC. To comply with the ATX specification there must be a smooth and continuous ramp of each DC input voltage from 10% to 90% of the DC input voltage final set point.

2.4.1.2. Power Supply Voltage Ripple

The maximum power supply voltage ripple is 100 mV peak-to-peak at 0 MHz – 20 MHz.

2.4.2. Power Management

Power management options are available within the BIOS setup.

ACPI Settings	ACPI 5.0
Miscellaneous Power Management	Supported in BIOS setup menu

Within the BIOS setup, If VCC power is removed, 5 V $\pm 5\%$ can be applied to the V_5V_STBY pins to support the following suspend states:

- ▶ Suspend to RAM (S3)
- ▶ Suspend-to-disk / Hibernate (S4)
- ▶ Soft-off state (S5)

The Wake-up event (S0) requires VCC power as the board is running.

2.4.3. Power Supply Control Settings

The power supply control settings are set in the BIOS and enable the module to shut down, rest and wake from standby properly.

The following table lists the implemented power supply control settings.

Power Button (PWRBTN#)	Pin B12	To start the module using the power button, the PWRBTN# signal must be at least 50 ms ($50 \text{ ms} \leq t < 4 \text{ s}$, typical 400 ms) at low level (Power Button Event). Pressing the power button for at least four seconds turns off power to the module (Power Button Override).
Power Good (PWR_OK)	Pin B24	PWR_OK is internally pulled up to 3.3 V and must be at the high level to power on the module. This can be driven low to hold the module from powering up as long as needed. The carrier needs to release the signal when ready. Low level prevents the module from entering the S0 state. A falling edge during S0 will cause a direct switch to S5 (Power Failure).
Reset Button (SYS_RESET#)	Pin B49	When the SYS_RESET# pin is detected active (falling edge triggered), it allows the processor to perform a "graceful" reset, by waiting up to 25 ms for the SMBus to go idle before forcing a reset, even though activity is still occurring. Once the reset is asserted, it remains asserted for 5 ms to 6 ms regardless of whether the SYS_RESET# input remains asserted or not.
SM-Bus Alert (SMB_ALERT#)	Pin B15	With an external battery manager present and SMB_ALERT# connected, the module always powers on even if the BIOS switch "After Power Fail" is set to "Stay Off".

2.4.4. Power Supply Modes

Setting the power supply controls enables the COMe-bKL6 to operating in either ATX power mode or in single power supply mode.

2.4.4.1. ATX Modes

To start the module in ATX mode and power VCC, follow the step below.

1. Connect the ATX PSU with VCC and 5 VSB, to set PWR_OK to low and VCC to 0 V.
2. Press the power button to set the PWR_OK to high and power VCC.

The PS_ON# signal generated by SUS_S3# (A15) indicates that the system is in the Suspend to RAM state. An inverted copy of SUS_S3# on the carrier board may be used to enable non-standby power on a typical ATX supply. The input voltage must always be higher than 5 V standby ($VCC > 5 \text{ VSB}$) for Computer-On-Modules supporting a wide input voltage range down to 8.5 V.

The following table lists the ATX mode settings.

State	PWRBTN#	PWR_OK	V5_StdBy	PS_ON#	VCC
G3	x	x	0 V	x	0 V
S5	high	low	5 V	high	0 V
S5 → S0	PWRBTN Event	low → high	5 V	high → low	0 V → VCC
S0	high	high	5 V	low	VCC

x – Signals are not relevant for the specific power state. It makes no difference if the signal is connected or open.

2.4.4.2. Single Supply Mode

In single supply mode, without 5 V standby, the module starts automatically if VCC power is connected and the Power Good input is open or at the high level (internal PU to 3.3 V).

PS_ON# is not used in single supply mode and the input voltage VCC range can be 8.5 V to 20 V.

To power on the module from S5 state, press the power button or reconnect VCC. Suspend/Standby states are not supported in single supply mode.

The following table lists the single supply mode settings.

State	PWRBTN#	PWR_OK	V5_StdBy	VCC
G3	x / 0 V	x / 0 V	x / 0 V	0 V
G3 → S0	high	open / high	open	connecting VCC
S5	high	open / high	open	VCC
S5 → S0	PWRBTN Event	open / high	open	reconnecting VCC

x - Signals are not relevant for the specific power state. It makes no difference if the signal is connected or open.



All ground pins must be connected to the carrier board's ground plane.

2.5. Thermal Management

2.5.1. Heatspreader and Active or Passive Cooling Solutions

A heatspreader plate assembly is available from Kontron for the COMe-bKL6. The heatspreader plate assembly is NOT a heat sink. The heatspreader works as a COM Express® standard thermal interface to be use with a heat sink or external cooling devices.

External cooling must be provided to maintain the heatspreader plate at proper operating temperatures. Under worst-case conditions, the cooling mechanism must maintain an ambient air and heatspreader plate temperature on any spot of the heatspreader's surface according to the module's specifications:

- ▶ 60°C for commercial temperature grade modules
- ▶ 75°C for extended temperature grade modules (E1)
- ▶ 85°C for industrial temperature grade modules by screening (E2S)

2.5.2. Active or Passive Cooling Solutions

Both active and passive thermal management approaches can be used with heatspreader plates. The optimum cooling solution varies, depending on the COM Express® application and environmental conditions. Active or passive cooling solutions provided from Kontron for the COMe-bKL6 are usually designed to cover the power and thermal dissipation for a commercial temperature range used in housing with proper airflow. For more information concerning possible cooling solutions, see Chapter 2.2 Accessories.

2.5.3. Operating with Kontron Heatspreader Plate (HSP) Assembly

The operating temperature defines two requirements:

- ▶ Maximum ambient temperature with ambient being the air surrounding the module
- ▶ Maximum measurable temperature on any spot on the heatspreader's surface

The heatspreader is tested for the temperature specifications listed in the table below.

Table 9: Heatspreader Test Temperature Specifications

Temperature Specification	Validation Requirements
Commercial Grade	at 60°C HSP temperature the CPU @ 100% load needs to run at nominal frequency
Extended Grade (E1)	at 75°C HSP temperature the CPU @ 75% load is allowed to start speedstepping for thermal protection
Industrial Grade by screening (E2S)	at 85°C HSP temperature the CPU @ 50% load is allowed to start throttling for thermal protection

2.5.4. Operating without Kontron Heatspreader Plate (HSP) Assembly

The operating temperature is the maximum measurable temperature on any spot on the module's surface.

2.5.5. On Board Fan Connector

The module's 3-pin fan connector powers, controls and monitors a fan for chassis ventilation.

Table 10: 3-Pin Fan Connector Pin Assignment

Pin	Signal	Description	Type
1	Fan_Tach_IN#	Input voltage	I
2	V_FAN	Limited to a max. 12 V ($\pm 10\%$) across the whole input range	PWR
3	GND	Power GND	PWR

To connect a standard 3-pin connector fan to the module, use one of the following adaptor cables:

- ▶ KAB-HSP 200 mm (PN 96079-0000-00-0)
- ▶ KAB-HSP 40 mm (PN 96079-0000-00-2)

If the input voltage is below 13 V, the maximum supply current to the on-board fan connector is 350 mA. The maximum supply current is limited to 150 mA if the input voltage is between 13 V and 20 V.

NOTICE

Always check the fan specification according to the limitations of the supply current and supply voltage.

Table 11: Electrical Characteristics of the Fan Connector

Module Input Voltage	< 13 V	13 V to 20 V
FAN Output Voltage	8.5 V to 13 V	12 V ($\pm 10\%$)
FAN Output Current	350 mA max.	150 mA

2.6. Environmental Specification

2.6.1. Temperature

Kontron defines the following temperature grades for Computer-On-Modules. For more information on the available temperature grades for the COMe-bKL6, see Chapter 2.1 Module Variants.

Table 12: Temperature Grade Specifications

Temperature Grades	Operating	Non-operating / Storage
Commercial Grade	0°C to +60°C	-30°C to +85°C
Extended Grade E1 (custom)	-25°C to +75°C	-30°C to +85°C
Industrial Grade R E2S (by screening)	-40°C to +85°C	-40°C to +85°C

2.6.2. Humidity

Table 13: Humidity Specification

Humidity	
Relative Humidity	93% at 40°C non-condensing (according to IEC 60068-2-78)

2.7. Standards and Certifications

The COMe-bKL6 complies with the following standards and certifications. For more information, contact Kontron Support.

Table 14: Standards and Certification Compliance

Emission (EMC)	<p>EN 55022: Class B Information technology equipment - Radio disturbance characteristics- Limits and methods of measurement</p> <p>IEC /EN 61000-6-3 Electromagnetic compatibility (EMC)- Part 6-3: Generic Standards- Emission standard for residential, commercial and light-industrial environments</p> <p>IEC/ EN 61000-3-2 Harmonic current emissions</p> <p>IEC / EN 61000-3-3 Voltage changes, voltage fluctuations and flicker</p>
Immunity (EMI)	<p>IEC / EN 61000-6-2 Electromagnetic compatibility (EMC) – Part 6-2: Generic standards - Immunity for industrial environments</p> <p>Immunity tests:</p> <p>IEC / EN 61000-4-2 - Electrostatic discharge (ESD) immunity</p> <p>IEC / EN 61000-4-3 – Radiated, radio frequency, electromagnetic field immunity</p> <p>IEC / EN 61000-4-4 - Electrical fast transient/burst immunity</p> <p>IEC / EN 61000-4-5 - Surge immunity</p> <p>IEC / EN 61000-4-6 - Immunity to conducted disturbances, induced by radio frequency fields</p> <p>IEC / EN 61000-4-8 - Power frequency magnetic field Immunity</p> <p>IEC / EN 61000-4-11 - Voltage dips, short interruptions, and voltage variation immunity</p>
Safety	<p>EN 62368-1 Safety for audio/video and information technology equipment</p> <p>UL 60950-1 / CSA 60950-1 Information Technology Equipment Including Electrical Business Equipment NWGQ2.E304278 NWGQ8.E304278</p>
Shock	<p>IEC / EN 60068-2-27 Non-operating shock – (half-sinusoidal, 11 ms, 15 g)</p>
Vibration	<p>IEC / EN 60068-2-6 Non-operating vibration – (sinusoidal, 10 Hz – 4000 Hz, +/- 0.15 mm, 2 g)</p>
(RoHS II)	<p>Compliant with the directive on the restriction of the use of certain hazardous substances in electrical and electronic equipment.</p>

2.7.1. MTBF

The MTBF (Mean Time Before Failure) values were calculated using a combination of the manufacturer's test data, (if available) and the Telcordia (Bellcore) issue 2 calculation for the remaining parts.

The Telcordia calculation used is "Method 1 Case 3" in a ground benign, controlled environment. This particular method takes into account varying temperature and stress data and the system is assumed to have not been burned-in. Other environmental stresses (such as extreme altitude, vibration, salt-water exposure) lower MTBF values.

Table 15: MTBF Estimated Values

MTBF
System MTBF(hours) = 598847 @ 40°C for the COMe-bKL6 i3-7102E CM238 Reliability report article number: 38032-0000-21-3
System MTBF(hours) = 542327 @ 40°C for the COMe-bKL6 E2S E3-1505M CM238 Reliability report article number: 38033-0000-30-4



Fans usually shipped with Kontron's modules have a 50,000 hour typical operating life. The MTBF estimated values above assumes no fan, but a passive heat sinking arrangement. Estimated RTC battery life (as opposed to battery failures) is not accounted for and needs to be considered separately. Battery life depends on both temperature and operating conditions. When the module is connected to an external power source, the only battery drain is from leakage paths.

Figure 2 and Figure 3 show the MTBF de-rating values for module used in the E1 (-25°C to +75°C) temperature range in an office or telecommunications environment. Other environmental stresses (extreme altitude, vibration, salt-water exposure, etc.) lower MTBF values.

Figure 2: MTBF De-rating Values @ 40°C for the COMe-bKL6 i3-7102E CM238 (MTBF: 598847 hours)

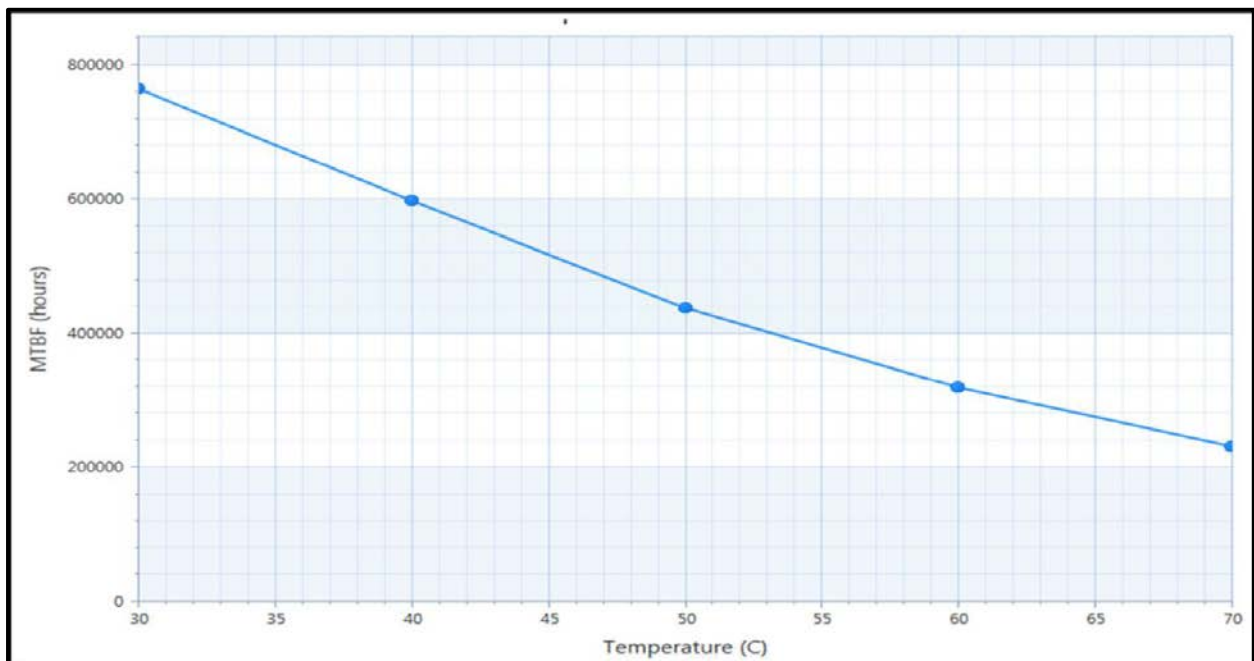
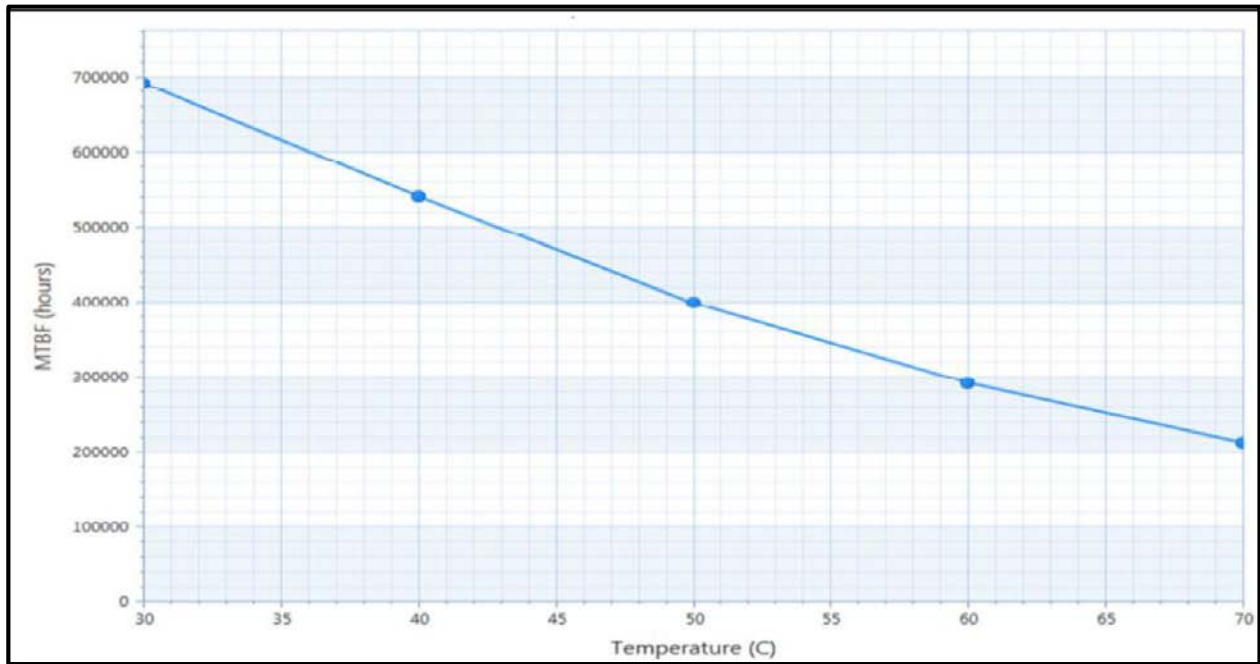

Figure 3: MTBF De-rating Values @ 40°C for the COMe-bKL6 E2S E3-1505M CM238 (MTBF: 542327 hours)



2.8. Mechanical Specification

2.8.1. Dimensions

The modules dimensions are:

- ▶ 95 mm x 125 mm (3.75 " x 4.92 ")

Figure 4: Module Dimensions

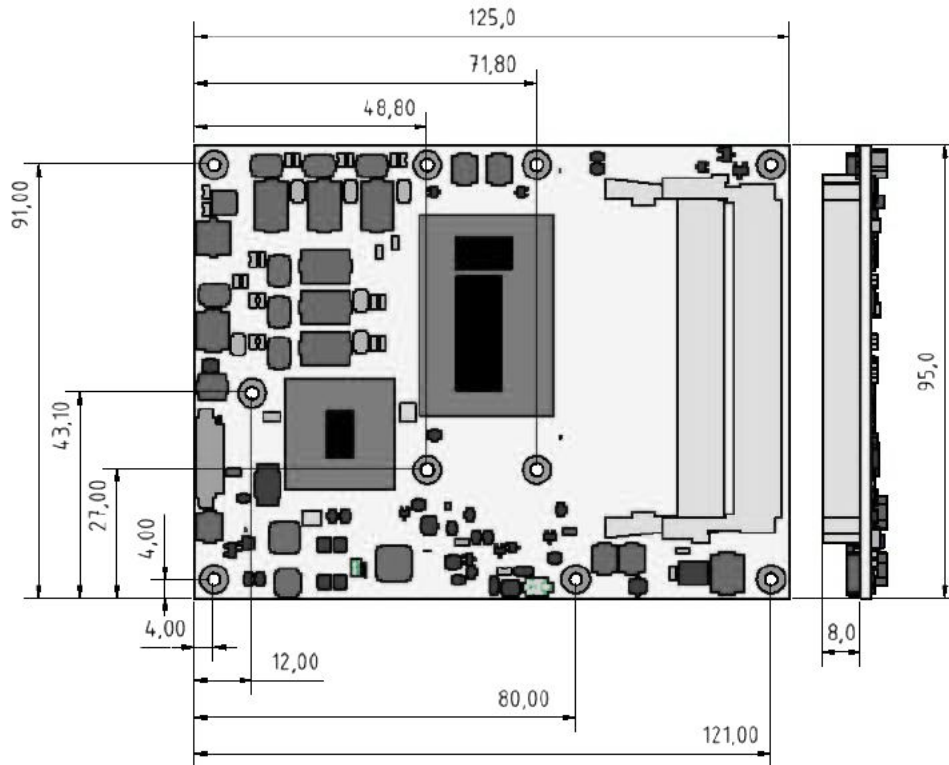

*All dimensions shown in mm.

2.8.2. Height

The height of the module depends on the height of the implemented cooling solution. The height of the cooling solution is not specified in the COM Express® specification.

The COM Express® specification defines a module height of approximately 13 mm from module PCB bottom to heatspreader top, as shown in Figure 5: Module Height below.

Figure 5: Module Height

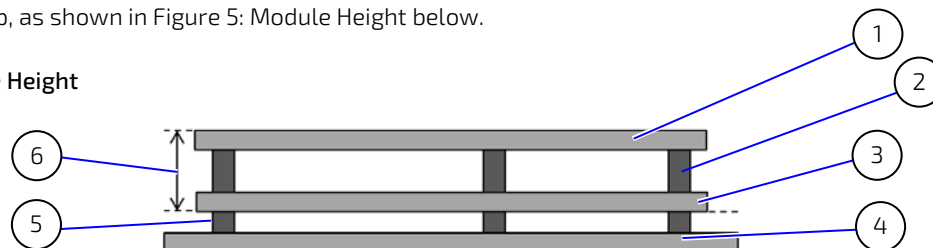

- | | |
|-----------------------------|---------------------------------------|
| 1. Heatspreader | 4. Carrier Board PCB |
| 2. Heatspreader standoff(s) | 5. Connector standoff(s) 5 mm or 8 mm |
| 3. Module PCB | 6. 13 mm +/- 0.65 mm |

2.8.3. Heatspreader Dimensions

The following figure shows the heatspreader's dimensions and location on the module.

Figure 6: Heatspreader Location and Dimensions

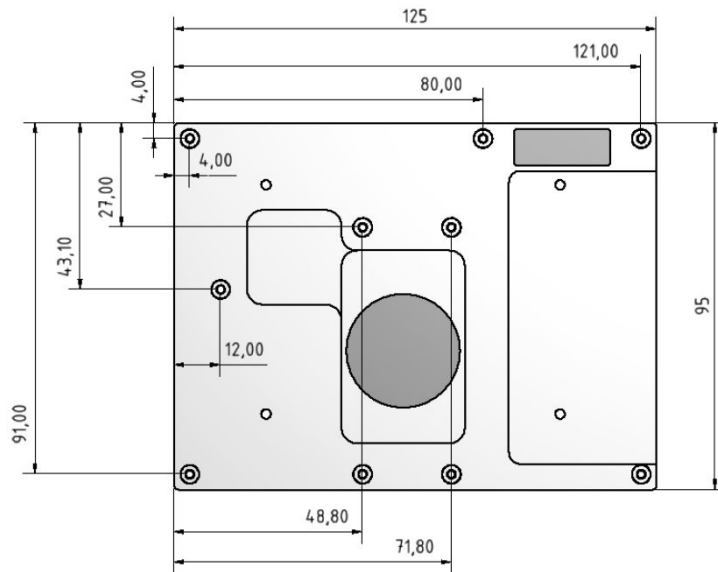

*All dimensions shown in mm.

3/ Features and Interfaces

3.1. Fast I2C

Fast I2C supports transfer between components on the same board. The COMe-bKL6 features an onboard I2C controller connected to the LPC Bus. The I2C controller supports:

- ▶ Multimaster transfers
- ▶ Clock stretching
- ▶ Collision detection
- ▶ Interruption on completion of an operation

3.2. GPIO

The eight GPIO pins support four inputs pins (A54 for GPIO, A63 for GPI1, A67 for GPI2 and A85 for GPI3) and four output pins (A93 for GPO0, B54 for GPO1, B57 for GPO2 and B63 for GPO3) by default. The four GPI [0-3] pins are pulled high with a pull-up resistor (e.g. 100 K ohms) and the four GPO [0-3] pins are pulled low with a pull-down resistor (e.g. 100 K ohms) on the module.

To change the default GPIO signal-state users are required to make BIOS and/or OS-driver changes, and additional hardware changes by adding external termination resistors on the carrier board to override the weak on-module pull-up resistors with a lower resistance pull-down (e.g. 10 K ohms), or pull-down resistors with a lower resistance pull-up (e.g. 10 K ohms).

3.3. Intel® Optane™ Memory

Intel® Optane™ memory is a system accelerator for 7th Gen Intel® Core™ processors. Intel® Optane™ memory combines the non-volatile 3D XPoint™ memory with advanced system controllers, and interface and software enhancements to provide a caching solution for accelerating systems with high capacity workloads.

Intel® Optane™ is available on the Rapid Storage capable PCIe Ports PCIe [0-3] and supports the x2 and x4 configuration options only. Owing to the fact that the PCIe [0-3] are configured as four times x1, Intel® Optane™ is only possible with a custom BIOS.

3.4. Kontron Security Solution (optional)

Kontron Security Solution is a combined hardware and software solution that includes an embedded hardware security module and a software framework to provide full protection for your application.

The optional integrated security module connects to USB2 port 9, supporting the following features:

- ▶ Copy protection
- ▶ IP protection
- ▶ License model enforcement

If required, customers can customize the solution to meet specific needs. For more information, contact Kontron Support.

3.5. LPC

The Low Pin Count (LPC) Interface signals are connected to the LPC Bus bridge located in the CPU or chipset. The LPC low speed interface can be used for peripheral circuits such as an external Super I/O Controller that typically combines legacy-device support into a single IC. The implementation of this subsystem complies with the COM

Express® specification. The COM Express® Design Guide maintained by PICMG provides implementation information or refer to the official PICMG documentation for more information.

The LPC bus does not support DMA (Direct Memory Access). When more than one device is used on LPC, a zero delay clock buffer is required. This leads to limitations for ISA bus and SIO (standard I/O(s) like floppy or LPT interfaces) implementations.

All Kontron COM Express® Computer-on-Modules imply BIOS support for the following external baseboard LPC Super I/O controller features for the Winbond/Nuvoton 83627DHG-P.

Table 16: Supported BIOS Features

3.3V 83627DHG-P	AMI EFI APTIO V
PS/2	Not supported
COM1/COM2	Supported
LPT	Not supported
HWM	Not supported
Floppy	Not supported
GPIO	Not supported

Features marked as not supported do not exclude OS support (e.g., HWM is accessible via SMB). If any other LPC Super I/O additional BIOS implementations are necessary, contact Kontron Support.

3.6. Rapid Shutdown

The rapid shutdown functions for R E2S modules functions as follows:

1. An active-high shutdown signal is asserted by the COM Express Eval Type 6 carrier board via pin C67 of the COM Express connector. The characteristics of the shutdown signal are as follows:
 - ▶ Amplitude 5.0V +/- 5%
 - ▶ Source impedance <= 50 ohms
 - ▶ Rise time <= 1uS
 - ▶ Duration >= 20uS

The assertion of this signal causes all power regulators to be disabled and the internal power supply rails to be discharged by crowbar circuits. The shutdown circuitry provides internal energy storage that maintains crowbar activation for at least 2 mS following the de-assertion of the shutdown signal. The circuit also incorporates a weak input pulldown resistor so that the R E2S module will operate normally in systems where the rapid shutdown functionality is not used and pin C67 of the COM Express is left unconnected.
2. Simultaneously with the leading edge of shutdown, the 12 V (main) input power to the R E2S module is removed and these input power pins are externally clamped to ground through a crowbar circuit located on the COM Express carrier board. This external clamping circuit must maintain a maximum resistance of approximately 1 ohm and be activated for a minimum of 2 mS.
3. Simultaneously with the leading edge of shutdown, the 5V (standby) input power to the R E2S module is removed, if present. External clamping on these pins is not necessary.

3.6.1. Crowbar Implementation Details

As a tool for designing the internal crowbars, Kontron calculated the total capacitance present on each of the internal power rails, and the required discharge resistance in order to achieve the desired voltage decay time constant. The principal design criteria are that each supply rail must decay to 37% of initial value (equivalent to 1RC) within 250 uS,

and to below 1.5 V within 2 mS. Analysis shows that the power rails fall into four general classes. Each class of power rails has a corresponding discharge strategy.

1. **Power Input Rails:** The main 12 V power input rail incorporates about 300 uF of distributed capacitance. This rail must be discharged by an external crowbar located on the carrier board that must provide a shunt resistance of approximately 1 ohm. The peak power dissipation in this crowbar resistance will be relatively high (on the order of 150 W when the crowbar is activated), but will diminish very rapidly as the input capacitors discharge.
2. **Low Voltage, High Power Rails:** Each of these five "major" internal supply rails has an output voltage in the 1.0 V to 1.5V range, and each rail has between 1500 uF and 3300 uF of output capacitance. The required discharge resistances for these rails are in the range of 0.1 ohm to 0.2 ohm, and peak discharge currents are in the range of 8 A to 16A.

The discharge circuit for each rail is implemented with a "pulse withstanding" thick-film SMT resistor in series with a low- R_{DSon} MOSFET. The resistor peak powers are in the 8 W to 20 W range; depending on PCB layout considerations either a single resistor or multiple smaller resistors may be used to achieve sufficient pulse handling capability.

Because of the relatively high currents in the discharge paths, these crowbar circuits require wide copper traces and careful component placement adjacent to the output components of the corresponding power supplies.

3. **Low Voltage, Low Power Rails:** These rails have voltages of 1.8 V or less and capacitances under 1000 uF, with peak discharge currents <3 A. The discharge circuits for these rails are also implemented with resistor(s) and a low- R_{DSon} MOSFET. In some cases, the peak pulse power dissipation in the resistor(s) is low enough that specialty "pulse withstanding" resistors are not required.
4. **Medium Voltage Rails:** These 3.3 V and 5 V rails typically have relatively small output capacitances and peak discharge currents <1 A. The discharge circuits for these rails are typically implemented with conventional resistor(s) and a low- R_{DSon} MOSFET.

3.6.2. Shutdown Input Circuit Details

The shutdown input pin to the R E2S module is coupled through a series Schottky diode and a small series resistor to the gates of all crowbar MOSFETs, connected in parallel. All crowbar MOSFETs are N-channel "logic level" parts that have are specified for operation at $V_{gs} = 4.5$ V. Three additional components are connected in parallel between the MOSFET gates and ground:

- ▶ A capacitor that provides energy storage to keep the MOSFETs conducting for several mS after the shutdown signal is de-asserted.
- ▶ A high-value resistor that provides a discharge path for the capacitor as well as a pulldown resistance (to insure that the shutdown circuits remain inactive if the shutdown pin is left floating).
- ▶ A 6.2V zener diode that protects the MOSFET gates from damage due to input ESD or input overdrive.

In order to insure that the crowbars do not "fight" active switching regulators while the input capacitors are being discharged, the shutdown circuit rapidly crowbars the 5 V rail, with a time constant <10 uS. The 5 V rail powers most of the remaining switching regulators, and as its voltage falls below about 4 V those regulators enter under-voltage lockout mode and cease to operate. Additionally, by using the UVLO mechanism in the design of the R E2S module, Kontron minimizes the risk of inadvertently affecting the standard power sequencing logic for such R E2S modules. Two of the switching regulators do not require the 5 V supply for operation, and in these cases it is necessary to clamp the enable inputs to ground when shutdown begins.

3.7. Real Time Clock (RTC)

The RTC keeps track of the current time accurately. The RTC's low power consumption means that the RTC can be powered from an alternate source of power enabling the RTC to continue to keep time while the primary source of power is off or unavailable.

The RTC battery voltage range is 2.8 V – 3.47 V. A typical RTC voltage is 3 V with a current of >10 µA if the module is powered by the mains supply the RTC voltage is generated by on-module regulators to reduce RTC current draw.

3.8. Serial Peripheral Interface (SPI)

The Serial Peripheral Interface Bus (SPI bus) is a synchronous serial data link standard. Devices communicate in master/slave mode, where the master device initiates the data frame. Multiple slave devices are allowed with individual slave select (chip select) lines. SPI is sometimes called a four-wire serial bus, contrasting with three, two and one-wire serial buses.



The SPI interface can only be used with a SPI flash device to boot from the external BIOS on the baseboard.

3.8.1. SPI boot

The COMe-bKL6 supports boot from a 16 MB, 3 V serial external SPI Flash. Pin A34 (BIOS_DIS0#) and pin B88 (BIOS_DIS1#) configure the SPI Flash as follows:

Table 17: SPI Boot Pin Configuration

Configuration	BIOS_DIS0#	BIOS_DIS1#	Function
1	open	open	Boot on module BIOS
2	GND	open	Not supported
3	open	GND	Boot on baseboard SPI
4	GND	GND	Not supported



BIOS does not support being split between two chips. Booting takes place either from the module SPI or from the baseboard SPI.

Table 18: Supported SPI Boot Flash Types for 8-SOIC Package

Size	Manufacturer	Part Number	Device ID
16MB	Maxim	MX25L12835F	0x20
16MB	Winbond	W25Q128FV	0x40
16MB	Micron	N25Q128A	0xBA

3.8.2. Using an External SPI Flash

Initially, boot on the EFI Shell with an USB key containing the binary used to flash the SPI, plugged in on the system.

Depending on which SPI you would like to flash, you will need to use the (BIOS_DIS1#) jumper located on the COM Express® carrier.

To flash the carrier or module Flash chip:

1. Connect a SPI flash with the correct size (similar to BIOS binary (*.BIN) file size) to the carrier SPI interface.
2. Open pin A34 (BIOS_DIS0#) and pin B88 (BIOS_DIS1#) to boot from the module BIOS.

3. Turn on the system and make sure your USB is connected then start the setup.
 4. Check that the following entries are set to their default setting:
Advanced > PCH FW Configuration > Firmware update configuration > ME FW Image Re-Flash > Disabled
Advanced > PCH FW Configuration > Firmware update configuration > Local FW Update > Enabled
 Then, change the setup option:
Chipset > PCH-IO Configuration > BIOS Security Configuration > BIOS Lock > Disabled
 5. Save and exit setup.
 6. Reboot system into EFI shell.
 7. Connect pin B88 (BIOS_DIS1#) to ground to enable the external SPI flash.
 8. From the EFI shell, enter the name of the partition of your USB Key in this example; Hit F50: then enter.
 9. Type `FPT -SAVEMAC -F <biosname>.BIN>`
 10. Wait until the program ends properly and then power cycle the whole system.
- The system is now updated.



Depending on the state of the external SPI flash, the program may display up to two warning messages printed in red. Do not stop the process at this point! After a few seconds of timeout, flashing proceeds. For more information, refer to the [EMD Customer Section](#).

3.8.3. External SPI flash on Modules with Intel® ME

If booting from the external (baseboard mounted) SPI flash then exchanging the COM Express® module for another module of the same type will cause the Intel® Management Engine (ME) to fail during the next start. This is due to the design of the ME that bounds itself to every module the ME was flashed to previously. In the case of an external SPI flash, this is the module present at flash time.

To avoid this issue, conduct a complete flash of the external SPI flash device after changing the COM Express® module for another module. If disconnecting and reconnecting the same module again, this step is not necessary.

3.9. SpeedStep® Technology

SpeedStep® technology enables you to adapt high performance computing to your applications by switching automatically between maximum performance mode and battery-optimized mode, depending on the needs of the application. When powered by a battery or running in idle mode, the processor drops to lower frequencies (by changing the CPU ratios) and voltage, thus conserving battery life while maintaining a high level of performance. The frequency is automatically set back to the high frequency, allowing you to customize performance.

In order to use the Intel® Enhanced SpeedStep® technology the operating system must support SpeedStep® technology.

By deactivating the SpeedStep® feature in the BIOS, manual control or modification of the CPU performance is possible. Setup the CPU Performance State in the BIOS Setup or use third party software to control the CPU Performance States.

3.10. Trusted Platform Module (TPM 2.0)

A Trusted Platform Module (TPM) stores RSA encryption keys specific to the host system for hardware authentication. The term TPM refers to the set of specifications applicable to TPM chips. The LPC bus connects the TPM chip to the CPU.

Each TPM chip contains an RSA key pair called the Endorsement Key (EK). The pair is maintained inside the chip and cannot be accessed by software. The Storage Root Key (SRK) is created when a user or administrator takes ownership of the system. This key pair is generated by the TPM based on the Endorsement Key and an owner-specified password.

A second key, called an Attestation Identity Key (AIK) protects the device against unauthorized firmware and software modification by hashing critical sections of firmware and software before they are executed. When the system attempts to connect to the network, the hashes are sent to a server that verifies that they match the expected values. If any of the hashed components have been modified since the last started, the match fails, and the system cannot gain entry to the network.

3.11. UART

The UART implements an interface for serial communications and supports up to two serial RX/TX ports defined in the COM Express® specification on pin A98 (SER0_TX) and pin A99 (SER0_RX) for UART0, and pin A101 (SER1_TX) and pin A102 (SER1_RX) for UART1.

The UART controller is fully 16550A compatible. UART features are:

- ▶ On-Chip bit rate (baud rate) generator
- ▶ No handshake lines
- ▶ Interrupt function to the host
- ▶ FIFO buffer for incoming and outgoing data

3.12. Watchdog Timer (WTD) – Dual Stage

A watchdog timer or (computer operating properly (COP) timer) is a computer hardware or software timer. If there is a fault condition in the main program, the watchdog triggers a system reset or other corrective actions. The intention is to bring the system back from the non-responsive state to normal operation.

Possible fault conditions are a hang, or neglecting to service the watchdog regularly. Such as writing a "service pulse" to it, also referred to as "kicking the dog", "petting the dog", "feeding the watchdog" or "triggering the watchdog".

The COMe-bKL6 offers a watchdog that works with two stages that can be programmed independently and used stage by stage.

Table 19: Dual Stage Watchdog Timer- Time-out Events

0000b	No action	The stage is off and will be skipped.
0001b	Reset	A reset restarts the module and starts a new POST and operating system.
0010b	NMI	A non-maskable interrupt (NMI) is a computer processor interrupt that cannot be ignored by standard interrupt masking techniques in the system. It is used typically to signal attention for non-recoverable hardware errors.
0011b	SMI	A system management interrupt (SMI) makes the processor entering the system management mode (SMM). As such, specific BIOS code handles the interrupt. The current BIOS handler for the watchdog SMI currently does nothing. For special requirements, contact Kontron Support.
0100b	SCI	A system control interrupt (SCI) is a OS-visible interrupt to be handled by the OS using AML code.

0101b	Delay -> No action*	Might be necessary when an operating system must be started and the time for the first trigger pulse must be extended. Only available in the first stage.
1000b	WDT Only	This setting triggers the WDT pin on the baseboard connector (COM Express® pin B27) only.
1001b	Reset + WDT	
1010b	NMI + WDT	
1011b	SMI + WDT	
1100b	SCI + WDT	
1101b	DELAY + WDT -> No action*	

3.12.1. WDT Signal

Watchdog time-out event (pin B27) on the COM Express® connector offers a signal that can be asserted when a watchdog timer has not been triggered within a set time. The WDT signal is configurable to either of the two stages. After reset, the signal is automatically deasserted. If deassertion is necessary during runtime, contact Kontron Support for further help.

4/ System Resources

4.1. Interrupt Request (IRQ) Lines

The following table specifies the device connected to each Interrupt line or if the line is available for new devices.

Table 20: Interrupt Requests

IRQ	General Usage	Project Usage
0	Timer	Timer
1	Keyboard	Keyboard (SuperIO)
2	Redirected secondary PIC	Redirected secondary PIC
3	COM2	COM2
4	COM1	COM1
5	LPT2/PCI devices	One of COM3+4
6	FDD	One of COM3+4 or not used
7	LPT1	LPT1 or one of COM3+4
8	RTC	RTC
9	SCI / PCI devices	Free for PCI devices
10	PCI devices	Free for PCI devices
11	PCI devices	Free for PCI devices
12	PS/2 mouse	Free for PCI devices
13	FPU	FPU
14	IDE0	Not used
15	IDE1	Not used

4.2. Memory Area

The following table specifies the usage of the address ranges within the memory area.

Table 21: Designated Memory Locations

Address Range (hex)	Size	Project Usage
00000000-0009FBFF	639 KB	Real mode memory
0009FC00-0009FFFF	1 KB	Extended BDA
000A0000-000BFFFF	128 KB	Display memory (legacy)
000C0000-000CBFFF	48 KB	VGA BIOS (legacy)
000CC000-000DFFFF	80 KB	Option ROM or XMS (legacy)
000E0000-000EFFFF	64 KB	System BIOS extended space (legacy)
000F0000-000FFFFF	64 KB	System BIOS base segment (legacy)
00100000-7FFFFFFF	128 MB	System memory (Low DRAM)
80000000-FFF00000	2 GB – 1 MB	PCI memory, other extensions (Low MMIO)
FEC00000-FEC00FFF	4 KB	IOxAPIC
FED00000-FED003FF	1 KB	HPET (Timer)
FED40000-FED40FFF	4KB	Always reserved for LPC TPM usage
FEE00000-FEEFFFFFFF	1MB	Local APIC region
FFFC0000-FFFFFFFF	256 KB	Mapping space for BIOS ROM/Boot vector
100000000-17FFFFFFF	2 GB	System memory (High DRAM)
180000000-F00000000	58 GB	High MMIO

4.3. I/O Address Map

The I/O port addresses are functionally identical to a standard PC/AT. All addresses not mentioned in this table should be available. We recommend that you do not use I/O addresses below 0100h with additional hardware for compatibility reasons, even if the I/O address is available.

Table 22: Designated I/O Port Address Ranges

I/O Address Range	General Usage	Project Usage
000-00F	DMA-Controller (Master) (8237)	DMA-Controller (Master) (8237)
020-021 024-025 028-029 02C-02D 030-031 034-035 038-039 03C-03D	Interrupt-Controller (Master) (8259)	Interrupt-Controller (Master) (8259)
02E-02F	SuperIO (Winbond)	External SuperIO (Winbond)
040-043 050-053	Programmable Interrupt Timer (8253)	Programmable Interrupt Timer (8253)
04E-04F	2 nd SuperIO, TPM etc.	TPM
060, 064	KBD Interface-Controller (8042)	KBD Interface-Controller (8042)
061, 063 065, 067	NMI Controller	NMI Controller
062, 066	Embedded Microcontroller	Not used
070-071	RTC CMOS / NMI mask	RTC CMOS / NMI mask
072-073	RTC Extended CMOS	RTC Extended CMOS
080-083	Debug port	Debug port
0A0-0A1 0A4-0A5 0A8-0A9 0AC-0AD 0B0-0B1 0B4-0B5 0B8-0B9 0BC-0BD	Interrupt-Controller (Slave) (8259)	Interrupt-Controller (Slave) (8259)
0B2-0B3	APM control	APM control
0C0-0DF	DMA-Controller (Slave) (8237)(N/A)	Not used
0F0-0FF	FPU (N/A)	Not used
170-177	HDD-Controller IDE1 Master	Not used
1F0-1F7	HDD-Controller IDE0 Master	Not used
200-207	Gameport	Not used
220-22F	Soundblaster®	Not used
279	ISA PnP	ISA PnP
278-27F	Parallel port LPT2	Not used
295-296	Hardware monitor (Winbond default)	Reserved (If SuperIO present)
2B0-2BF	EGA	Not used
2D0-2DF	EGA	Not used
2E8-2EF	Serial port COM 4	Serial port COM4 (optional)
2F8-2FF	Serial port COM 2	Serial port COM2 from CPLD

I/O Address Range	General Usage	Project Usage
300-301	MIDI	Not used
300-31F	System specific peripherals	Not used
370-377	Floppy disk controller	Not used
376-377	HDD-Controller IDE1 Slave	Not used
378-37F	Parallel port LPT 1	LPT1 (If SuperIO present)
3BC-3BF	Parallel port LPT3	Not used
3C0-3CF	VGA/EGA	VGA/EGA
3D0-3DF	CGA	Not used
3E0-3E1	PCMCIA ExCA interface	Not used
3E8-3EF	Serial port COM3	Serial port COM3 (optional)
3F0-3F7	Floppy Disk Controller	Not used
3F6-3F7	HDD controller IDE0 Slave	Not used
3F8-3FF	Serial Port COM1	Serial port COM1
4D0-4D1	Interrupt-Controller (Slave)	Interrupt-Controller (Slave)
A80-A81	Kontron CPLD	Kontron CPLD control port
CF8	PCI configuration address	PCI configuration address
CF9	Reset control	Reset control
CFC-CFF	PCI configuration data	PCI configuration data



Other PCI device I/O addresses are allocated dynamically and not listed here. For more information on how to determine I/O address usage, refer to the OS documentation.

4.4. Peripheral Component Interconnect (PCI) Devices

All devices follow the Peripheral Component Interconnect 2.3 (PCI 2.3) and PCI Express Base 1.0a specification. The BIOS and Operating Software (OS) control the memory and I/O resources. For more information, refer to the PCI 2.3 specification.

4.5. I2C Bus

The following table provides the I2C address for devices connected the I2C Bus.

Table 23: I2C Bus Port Addresses

I2C Address	Used For	Available	Comment
58h		No	Internally reserved
A0h	JIDA-EEPROM	No	Module EEPROM
AEh	FRU-EEPROM	No	Recommended for Baseboard EEPROM

4.6. System Management (SM) Bus

The 8-bit SMBus address uses the LSB (Bit 0) for the direction of the device.

- ▶ Bit0 = 0 defines the write address
- ▶ Bit0 = 1 defines the read address

The 8-bit address listed below shows the write address for all devices. The 7-bit SMBus address shows the device address without Bit0.

Table 24: SMBus Addresses

8-bit Address	7-bit Address	Device	Comment	SMBus
5Ch	2Eh	HWM NCT7802Y	Do not use under any circumstances	SMB
A0h	50h	SPD DDR Channel 1 (SO-DIMM)		SMB
A4h	52h	SPD DDR Channel 2 (SO-DIMM)		SMB
30h	18h	SO-DIMM Thermal Sensor	If available on the used memory-module	SMB
34h	1Ah	SO-DIMM Thermal Sensor channel 2	If available on the used memory-module	SMB

5/ COMe Interface Connectors

The COMe-bKL6 is a COM Express® basic module containing two 220-pin connectors; each with two rows called row A & row B on the primary connector and row C & row D on the secondary connector.

The following figure is a view from the bottom of the module showing the position of interface connectors X1A and X1B.

Figure 7: X1A and X1B COMe Interface Connectors.

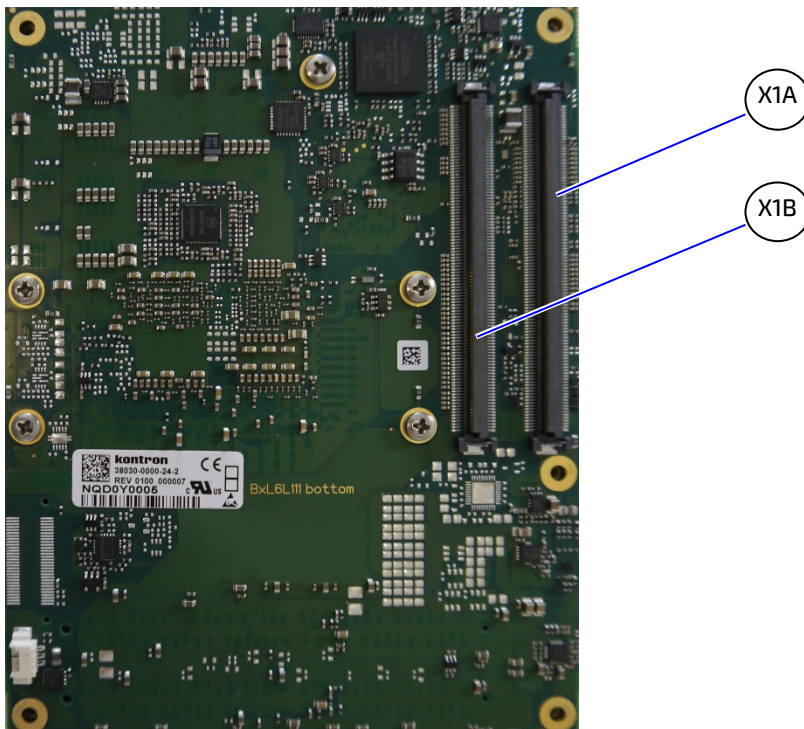

5.1. X1A and X1B Signals

For description of the terms used within the pin assignment tables, see the General Signals Description table below or Appendix A, List of Acronyms. If a more detailed pin assignment description is required, refer to the PICMG specification COMe Rev 2.1 Type 6 standard.



The information provided under type, module terminations and comments is complimentary to the COM.0 Rev 2.1 Type 6 standard. For more information, contact Kontron Support.

Table 25: General Signal Description

Type	Description	Type	Description
NC	Not Connected (on this product)	O-1,8	1.8 V Output
I/O-3,3	Bi-directional 3.3 V I/O-Signal	O-3,3	3.3 V Output
I/O-5T	Bi-dir. 3.3 V I/O (5 V Tolerance)	O-5	5 V Output
I/O-5	Bi-directional 5V I/O-Signal	DP-I/O	Differential Pair Input/Output
I-3,3	3.3 V Input	DP-I	Differential Pair Input
I/OD	Bi-directional Input/Output Open Drain	DP-O	Differential Pair Output
I-5T	3.3 V Input (5 V Tolerance)	PU	Pull-Up Resistor
OA	Output Analog	PWR	Power Connection
OD	Output Open Drain	+ and -	Differential Pair

NOTICE

To protect external power lines of peripheral devices, make sure that the wires have the right diameter to withstand the maximum available current.

The enclosure of the peripheral device fulfills the fire-protection requirements of IEC/EN60950.

5.2. X1A and X1B Pin Assignment

For more information regarding the pin assignment of connector X1A (row A and row B) and connector X1B (row C and row D), see the pin assignment tables:

- ▶ Table 26: Connector X1A Row A Pin Assignment (A1-A110)
- ▶ Table 27: Connector X1A Row B Pin Assignment (B1-B110)
- ▶ Table 28: Connector X1B Row C Pin Assignment (C1-C110)
- ▶ Table 29: Connector X1B Row D Pin Assignment (D1-D110)

5.2.1. Connector X1A Row A1 - A110

Table 26: Connector X1A Row A Pin Assignment (A1-A110)

Pin	COMe Signal	Description	Type	Termination	Comment
A1	GND	Power ground	PWR GND		
A2	GBE0_MDI3-	Ethernet media dependent interface 3	DP-I/O		
A3	GBE0_MDI3+				
A4	GBE0_LINK100#	Ethernet speed indicator	OD		
A5	GBE0_LINK1000#				
A6	GBE0_MDI2-	Ethernet media dependent Interface 2	DP-I/O		
A7	GBE0_MDI2+				
A8	GBE0_LINK#	Ethernet link indicator	OD		
A9	GBE0_MDI1-	Ethernet media dependent interface 1	DP-I/O		
A10	GBE0_MDI1+				
A11	GND	Power ground	PWR GND		
A12	GBE0_MDI0-	Ethernet media dependent interface 0	DP-I/O		
A13	GBE0_MDI0+				
A14	GBE0_CTREF	Reference voltage for Carrier Board Ethernet magnetics center tab. The reference voltage is determined by the requirements of the module PHY and may be as low as 0V and as high as 3.3V.	0		1 uF capacitor to GND
A15	SUS_S3#	Indicates system is in Suspend to RAM (or deeper) state. An inverted copy of SUS_S3# on Carrier Board may be used to enable non-standby power on a typical ATX supply.	0-3.3	PD 10 kΩ	
A16	SATA0_TX+	Serial ATA transmit data pair 0	DP-0		
A17	SATA0_TX-				
A18	SUS_S4#	Indicates system is in Suspend to Disk (or deeper) state.	0-3.3	PD 10 kΩ	
A19	SATA0_RX+	Serial ATA receive data pair 0	DP-I		
A20	SATA0_RX-				
A21	GND	Power ground	PWR GND		
A22	SATA2_TX+	Serial ATA transmit data pair 2	DP-0		
A23	SATA2_TX-				
A24	SUS_S5#	Indicates system is in Soft Off state.	0-3.3		
A25	SATA2_RX+	Serial ATA receive data pair 2	DP-I		
A26	SATA2_RX-				
A27	BATLOW#	Provides a battery-low signal to the module to indicate external battery is low	I-3.3	PU 10 kΩ, 3.3 V (S5)	Assertion prevents wake from S3-S5 state
A28	ATA_ACT#	Serial ATA activity LED indicator	OD-3.3	PU 10 kΩ, 3.3 V (S0)	Can sink 15 mA
A29	HDA_SYNC	HD audio sync	0-3.3	PD 20 kΩ in PCH	
A30	HDA_RST#	HD audio reset	0-3.3	PD 20 kΩ in PCH	
A31	GND	Power ground	PWR GND		
A32	HDA_CLK	HD audio bit clock output	0-3.3	PD 20 kΩ in PCH	
A33	HDA_SDOOUT	HD audio serial data out	0-3.3	PD 20 kΩ in PCH	
A34	BIOS_DIS0#	BIOS selection straps to determine the BIOS boot device	I-3.3	PU 10 kΩ, 3.3 V (S5)	The Carrier should only float these or pull them low.
A35	THRMTRIP#	Thermal trip Indicates CPU has entered thermal shutdown	0-3.3	PU 10 kΩ, 3.3 V (S0)	Thermal trip event transition to S5 indicator
A36	USB6-	USB 2.0 data differential pair port 6	DP-I/O	PD 14.25 kΩ to 24.8 kΩ in PCH	
A37	USB6+				
A38	USB_6_7_OC#	USB overcurrent indicator port 6/7	I-3.3	PU 10 kΩ, 3.3 V (S5)	

Pin	COMe Signal	Description	Type	Termination	Comment
A39	USB4-	USB 2.0 data differential pair port 4	DP-I/O	PD 14.25 k Ω to 24.8 k Ω in PCH	
A40	USB4+				
A41	GND	Power ground	PWR GND		
A42	USB2-	USB 2.0 data differential pair port 2	DP-I/O	PD 14.25 k Ω to 24.8 k Ω in PCH	
A43	USB2+				
A44	USB_2_3_OC#	USB overcurrent indicator port 2/3	I-3.3	PU 10 k Ω 3.3 V (S5)	An open drain driver from a USB current monitor on the Carrier Board may drive this line low. Do not pull this line high on the Carrier Board.
A45	USB0-	USB 2.0 data differential pairs port 0	DP-I/O	PD 14.25 k Ω to 24.8 k Ω in PCH	
A46	USB0+				
A47	VCC_RTC	Real Time Clock (RTC) circuit power input	PWR 3V		Voltage 2.8 V to 3.47 V
A48	EXCD0_PERST#	ExpressCard reset port 0	0-3.3	PD 10 k Ω	
A49	EXCD0_CPPE#	ExpressCard capable card request port 0	I-3.3	PU 10 k Ω 3.3 V (S0)	
A50	LPC_SERIRQ	Serial interrupt request	I/OD-3.3	PU 8.2 k Ω , 3.3 V (S0)	
A51	GND	Power ground	PWR GND		
A52	PCIE_TX5+	PCI Express transmit lane 5	DP-0		
A53	PCIE_TX5-				
A54	GPIO	General purpose input 0	I-3.3	PU 100 k Ω , 3.3 V (S0)	
A55	PCIE_TX4+	PCI Express transmit lane 4	DP-0		
A56	PCIE_TX4-				
A57	GND	Power ground	PWR GND		
A58	PCIE_TX3+	PCI Express transmit lane 3	DP-0		
A59	PCIE_TX3-				
A60	GND	Power Ground	PWR GND		
A61	PCIE_TX2+	PCI Express transmit lane 2	DP-0		
A62	PCIE_TX2-				
A63	GPI1	General purpose input 1	I-3.3	PU 100 k Ω , 3.3 V (S0)	
A64	PCIE_TX1+	PCI Express transmit lane 1	DP-0		
A65	PCIE_TX1-				
A66	GND	Power ground	PWR GND		
A67	GPI2	General purpose input 2	I-3.3	PU 100 k Ω , 3.3 V (S0)	
A68	PCIE_TX0+	PCI Express transmit lane 0	DP-0		
A69	PCIE_TX0-				
A70	GND	Power ground	PWR GND		
A71	LVDS_A0+	LVDS channel A DAT0 or EDP Lane 2 transmit	DP-0		
A72	LVDS_A0-				
A73	LVDS_A1+	LVDS channel A DAT1 or EDP Lane 1 transmit	DP-0		
A74	LVDS_A1-				
A75	LVDS_A2+	LVDS channel A DAT2 or EDP Lane 0 transmit	DP-0		
A76	LVDS_A2-				
A77	LVDS_VDD_EN	LVDS or EDP panel power control	0-3.3	PD 100 k Ω	
A78	LVDS_A3+	LVDS channel A DAT3 transmit	DP-0		
A79	LVDS_A3-				
A80	GND	Power ground	PWR GND		
A81	LVDS_A_CLK+	LVDS Channel A clock or EDP lane 3 transmit	DP-0		Clock 20 MHz to 80 MHz

Pin	COMe Signal	Description	Type	Termination	Comment
A82	LVDS_A_CK-				
A83	LVDS_I2C_CK	I2C Clock for LVDS display use or eDP AUX +	I/O-3.3	PU 2.2 k Ω , 3.3 V (S0)	
A84	LVDS_I2C_DAT	I2C Data line for LVDS display use or eDP AUX -	I/O-3.3	PU 2.2 k Ω , 3.3 V (S0)	
A85	GPI3	General purpose input 3	I-3.3	PU 100 k Ω 3.3 V (S0)	
A86	RSVD	Reserved for future use	NC		
A87	eDP_HPD	Detection of Hot Plug / unplug	I-3.3	PD 400 k Ω LVDS / 100 k Ω EDP	
A88	PCIE_CK_REF+	Reference PCI Express clock for all PCI Express and PCI Express graphics lanes	DP-0		100 MHz
A89	PCIE_CK_REF-				
A90	GND	Power ground	PWR GND		
A91	SPI_POWER	3.3 V power output for external SPI Flash	O-3.3		100 mA maximum Only use to power SPI devices on Carrier Board.
A92	SPI_MISO	Data in to module from carrier SPI (SPI Master IN Slave Out)	I-3.3	PU 15 k Ω to 40 k Ω in PCH	All SPI signals tri-stated until reset deasserted.
A93	GPO0	General purpose output 0	O-3.3	PD 100 k Ω	
A94	SPI_CLK	Clock from module to carrier SPI	O-3.3	PU 15 k Ω to 40 k Ω in PCH (S5)	All SPI signals tri-stated with 20 K Ω CPU internal weak pull-up until reset deasserted.
A95	SPI_MOSI	Data out from module to carrier SPI	O-3.3	PU 15 k Ω to 40 k Ω in PCH (S5)	
A96	TPM_PP	TPM physical presence	I-3.3	PD 10 k Ω	TPM does not use this functionality.
A97	TYPE10#	Indicates to carrier board that Type 10 module is installed	NC		
A98	SER0_TX	Serial port 0 TXD	O-3.3		20 V protection circuit implemented on-module, PD on carrier boards needed for proper operation.
A99	SER0_RX	Serial port 0 RXD	I-5T	PU 47 k Ω , 3.3 V (S0)	20 V protection circuit implemented on-module.
A100	GND	Power ground	PWR GND		
A101	SER1_TX	Serial port 1 TXD	O-3.3		20 V protection circuit implemented on-module, PD on carrier board needed for proper operation.
A102	SER1_RX	Serial port 1 RXD	I-5T	PU 47 k Ω , 3.3 V (S0)	20 V protection circuit implemented on-module.
A103	LID#	LID switch input	I-3.3	PU 47 k Ω , 3.3 V (S5)	
A104	VCC_12V	Main input voltage (4.75 V - 20V)	PWR 4.75 V - 20 V		
A105	VCC_12V				
A106	VCC_12V				
A107	VCC_12V				
A108	VCC_12V				
A109	VCC_12V				
A110	GND	Power ground	PWR GND		

+ and - Differential pair differentiator

5.2.2. Connector X1A Row B1 - B100

Table 27: Connector X1A Row B Pin Assignment (B1-B110)

Pin	COMe Signal	Description	Type	Termination	Comment
B1	GND	Power Ground	PWR GND		
B2	GBE0_ACT#	Ethernet activity LED indicator	OD		
B3	LPC_FRAME#	Indicates the start of an LPC cycle	0-3.3		
B4	LPC_AD0	LPC multiplexed command, address and data bus	I/O-3.3	PU 15 K Ω -40 K Ω in PCH (S5)	
B5	LPC_AD1				
B6	LPC_AD2				
B7	LPC_AD3				
B8	LPC_DRQ0#	LPC serial DMA master request	NC		
B9	LPC_DRQ1#				
B10	LPC_CLK	LPC 24 MHz clock output	0-3.3	PD 20 K Ω in PCH	24 MHz
B11	GND	Power Ground	PWR GND		
B12	PWRBTN#	Power Button - a falling edge creates a power button event	I-3.3	PU 10 K Ω , 3.3 V (S5eco)	Power button events can be used to bring a system out of S5 soft-off and other suspend states, as well as powering the system down.
B13	SMB_CLK	SMBus clock line	0-3.3	PU 2.56 K Ω , 3.3 V (S5)	
B14	SMB_DAT	SMBus bidirectional data line	I/O-3.3	PU 2.56 K Ω , 3.3 V (S5)	
B15	SMB_ALERT#	SMBus alert can be used to generate a SMI# or to wake the system	I/O-3.3	PU 2.2 K Ω , 3.3 V (S5)	
B16	SATA1_TX+	SATA 1 transmit data pair	DP-0		
B17	SATA1_TX-				
B18	SUS_STAT#	Indicates imminent suspend operation; used to notify LPC devices.	0-3.3		
B19	SATA1_RX+	SATA 1 receive data pair	DP-I		
B20	SATA1_RX-				
B21	GND	Power Ground	PWR GND		
B22	SATA3_TX+	SATA 3 transmit data pair	DP-0		
B23	SATA3_TX-				
B24	PWR_OK	Power OK from main power supply.	I-5T	PU 61 K Ω , 3.3 V	20 V protection circuit implemented on module
B25	SATA3_RX+	SATA 3 receive data pair	DP-I		
B26	SATA3_RX-				
B27	WDT	Watchdog time-out event has occurred	0-3.3	PD 10 K Ω	
B28	HDA_SDIN2	Audio Codec Serial data input 2	NC		Not supported
B29	HDA_SDIN1	Audio Codec Serial data input 1	I-3.3	PD 20 K Ω in PCH	
B30	HDA_SDIN0	Audio Codec Serial data input 0			
B31	GND	Power Ground	PWR GND		
B32	SPKR	Speaker output provides the PC beep signal and is mainly intended for debugging purposes	0-3.3	PD 20 K Ω in PCH	PD is enabled until reset is deasserted
B33	I2C_CLK	General purpose I2C port clock output	0-3.3	PU 2.21 K Ω , 3.3 V (S5)	
B34	I2C_DAT	General purpose I2C port data I/O line	I/O-3.3	PU 2.21 K Ω , 3.3 V (S5)	
B35	THRM#	Input from off-Module temp sensor indicating an over-temp situation	I-3.3	PU 10 K Ω to 3.3 V (S0)	No function implemented
B36	USB7-	USB 2.0 differential data pairs port 7	DP-I/O	PD 14.25 K Ω to 24.8 K Ω in PCH	
B37	USB7+				

Pin	COMe Signal	Description	Type	Termination	Comment
B38	USB_4_5_OC#	USB overcurrent indicator port 4/5	I-3.3	PU 10 K Ω , 3.3 V (S5)	
B39	USB5-	USB 2.0 differential data pairs port 5	DP-I/O	PD 14.25 K Ω to 24.8 K Ω in PCH	
B40	USB5+				
B41	GND	Power Ground	PWR GND		
B42	USB3-	USB 2.0 differential data pairs port 3	DP-I/O	PD 14.25 K Ω to 24.8 K Ω in PCH	
B43	USB3+				
B44	USB_0_1_OC#	USB overcurrent indicator port 0/1	I-3.3	PU 10 K Ω , 3.3 V (S5)	
B45	USB1-	USB 2.0 differential data pairs port 1	DP-I/O	PD 14.25 K Ω to 24.8 K Ω in PCH	
B46	USB1+				
B47	EXCD1_PERST#	ExpressCard expansion, reset port 1	O-3.3	PD 10 K Ω	
B48	EXCD1_CPPE#	ExpressCard expansion, capable card request port 1	I-3.3	PU 10K Ω , 3.3 V (S0)	
B49	SYS_RESET#	Reset button input	I-3.3	PU 10 K Ω , 3.3 V (S5)	
B50	CB_RESET#	Reset output from module to carrier board	O-3.3	PU 10 K Ω , 3.3 V (S5)	
B51	GND	Power Ground	PWR GND		
B52	PCIE_RX5+	PCI Express receive lane 5	DP-I		
B53	PCIE_RX5-				
B54	GPO1	General purpose output 1	O-3.3	PD 100 K Ω	
B55	PCIE_RX4+	PCI Express receive lane 4	DP-I		
B56	PCIE_RX4-				
B57	GPO2	General purpose output 2	O-3.3	PD 100 K Ω	
B58	PCIE_RX3+	PCI Express receive lane 3	DP-I		
B59	PCIE_RX3-				
B60	GND	Power Ground	PWR		
B61	PCIE_RX2+	PCI Express receive lane 2	DP-I		
B62	PCIE_RX2-				
B63	GPO3	General purpose output 3	O-3.3	PD 100 K Ω	
B64	PCIE_RX1+	PCI Express receive lane 1	DP-I		
B65	PCIE_RX1-				
B66	WAKE0#	PCI Express Wake Event wake up signal	I-3.3	PU 10 K Ω , 3.3 V (S5)	
B67	WAKE1#	General purpose Wake Event wake up signal, to implement wake-up on PS2 keyboard or mouse	I-3.3	PU 10 K Ω , 3.3 V (S5)	
B68	PCIE_RX0+	PCI Express receive lane 0	DP-I		
B69	PCIE_RX0-				
B70	GND	Power Ground	PWR GND		
B71	LVDS_B0+	LVDS Channel B DAT0	DP-O		
B72	LVDS_B0-				
B73	LVDS_B1+	LVDS Channel B DAT1	DP-O		
B74	LVDS_B1-				
B75	LVDS_B2+	LVDS Channel B DAT2	DP-O		
B76	LVDS_B2-				
B77	LVDS_B3+	LVDS Channel B DAT3	DP-O		
B78	LVDS_B3-				
B79	LVDS/BKLT_EN	LVDS or EDP panel backlight enable (ON)	O-3.3	PD 100 K Ω	
B80	GND	Power Ground	PWR GND		
B81	LVDS_B_CLK+	LVDS Channel B Clock	DP-O		20 MHz -80 MHz
B82	LVDS_B_CLK-				
B83	LVDS_BKLT_CTRL	LVDS or EDP panel backlight brightness control	O-3.3		

Pin	COMe Signal	Description	Type	Termination	Comment
B84	VCC_5V_SBY	5V Standby	PWR 5 V (S5)		Optional, not necessary in single supply mode
B85	VCC_5V_SBY				
B86	VCC_5V_SBY				
B87	VCC_5V_SBY				
B88	BIOS_DIS1#	BIOS selection strap to determine BIOS boot device	I-3.3	PU 10 K Ω , 3.3 V (S0)	PU might be powered during suspend
B89	VGA_RED	CRT Red/ Analog Video RGB-RED	OA	PD 150 Ω	Only on VGA option
B90	GND	Power Ground	PWR GND		
B91	VGA_GREEN	VGA Green/ Analog Video RGB-Green	OA	PD 150 Ω	Only on VGA option
B92	VGA_BLUE	VGA Blue/ Analog Video RGB-Blue	OA	PD 150 Ω	
B93	VGA_HSYNC	Analog horizontal sync output to VGA monitor	0-3.3		
B94	VGA_VSYNC	Analog vertical sync output to VGA monitor	0-3.3		
B95	VGA_DDC_CLK	Display Data Channel (DDC) clock line	I/O-5	PU 2.4 K Ω , 3.3 V (S0)	
B96	VGA_DDC_DATA	Display Data Channel (DDC) data line	I/O-5	PU 2.4 K Ω , 3.3 V (S0)	
B97	SPI_CS#	Chip select for carrier board SPI	0 3.3		
B98	RSVD	Reserved for future use	NC		
B99	RSVD				
B100	GND	Power Ground	PWR GND		
B101	FAN_PWMOUT	Fan speed control by PWM Output	0-3.3		20 V protection circuit implemented on module, PD on carrier board needed for proper operation
B102	FAN_TACHIN	Fan tachometer input for fan with a two-pulse output	I-3.3	PU 47 K Ω , 3.3 V (S0)	20 V protection circuit implemented on module
B103	SLEEP#	Sleep button signal used by ACPI operating system to bring system to sleep state or wake it up again	I-3.3	PU 47 K Ω , 3.3 V (S5)	
B104	VCC_12V	Main input voltage (4.75 V - 20 V)	PWR 4.75 V-20 V		
B105	VCC_12V				
B106	VCC_12V				
B107	VCC_12V				
B108	VCC_12V				
B109	VCC_12V				
B110	GND	Power Ground	PWR GND		

+ and - Differential pair differentiator

5.2.3. Connector X1B Row C1 - C110

Table 28: Connector X1B Row C Pin Assignment (C1-C110)

Pin	COMe Signal	Description	Type	Termination	Comment
C1	GND	Power Ground	PWR GND		
C2	GND				
C3	USB_SSRX0-	USB SuperSpeed receive data pair 0	DP-I		
C4	USB_SSRX0+				
C5	GND	Power Ground	PWR GND		
C6	USB_SSRX1-	USB SuperSpeed receive data pair 1	DP-I		
C7	USB_SSRX1+				
C8	GND	Power Ground	PWR GND		
C9	USB_SSRX2-	USB SuperSpeed receive data pair 2	DP-I		
C10	USB_SSRX2+				
C11	GND	Power Ground	PWR GND		
C12	USB_SSRX3-	USB SuperSpeed receive data pair3	DP-I		
C13	USB_SSRX3+				
C14	GND	Power Ground	PWR GND		
C15	DDI1_PAIR6+	DDI1 data pair 6	NC		
C16	DDI1_PAIR6-				
C17	RSVD	Reserved for future use	NC		
C18	RSVD				
C19	PCIE_RX6+	PCI Express receive lane 6	DP-I		
C20	PCIE_RX6-				
C21	GND	Power Ground	PWR GND		
C22	PCIE_RX7+	PCI Express receive lane 7	DP-I		
C23	PCIE_RX7-				
C24	DDI1_HPD	DDI1 Hotplug Detect	I-3.3	PD 100 K Ω	
C25	DDI1_PAIR4+	DDI1 data pair 4	NC		
C26	DDI1_PAIR4-				
C27	RSVD	Reserved for future use	NC		
C28	RSVD				
C29	DDI1_PAIR5+	DDI1 data pair 5	NC		
C30	DDI1_PAIR5-				
C31	GND	Power Ground	PWR GND		
C32	DDI2_CTRLCLK_AUX+	DDI2 clock	I/O-3.3	PD 100 K Ω	
C33	DDI2_CTRLDATA_AUX-	DDI2 date	I/O-3.3	PU 100 K Ω , 3.3 V (S0)	
C34	DDI2_DDC_AUX_SEL	DDI2 select	I-3.3	PD 1 M Ω	
C35	RSVD	Reserved for future use	NC		
C36	DDI3_CTRLCLK_AUX+	DDI3 clock	I/O-3.3	PD 100 K Ω	
C37	DDI3_CTRLDATA_AUX-	DDI3 date	I/O-3.3	PD 100 K Ω , 3.3 V (S0)	
C38	DDI3_DDC_AUX_SEL	DDI3 select	I-3.3	PD 1 M Ω	
C39	DDI3_PAIR0+	DDI3 data pair 0	DP-O		
C40	DDI3_PAIR0-				
C41	GND	Power Ground	PWR GND		
C42	DDI3_PAIR1+	DDI3 data pair 1	DP-O		
C43	DDI3_PAIR1-				
C44	DDI3_HPD	DDI3 Hotplug Detect	I-3.3	PD 100 K Ω	
C45	RSVD	Reserved for future use	NC		
C46	DDI3_PAIR2+	DDI3 data pair 2	DP-O		

Pin	COMe Signal	Description	Type	Termination	Comment
C47	DDI3_PAIR2-				
C48	RSVD	Reserved for future use	NC		
C49	DDI3_PAIR3+	DDI3 data pair	DP-0		
C50	DDI3_PAIR3-				
C51	GND	Power Ground	PWR GND		
C52	PEG_RX0+	PCI Express Graphics (PEG) receive lane 0	DP-I		
C53	PEG_RX0-				
C54	TYPE0#	Indicates the Carrier Board the pinout type and is not connected for type 6.	NC		NC for Type 6 module
C55	PEG_RX1+	PCI Express Graphics (PEG) receive lane 1	DP-I		
C56	PEG_RX1-				
C57	TYPE1#	Indicates the Carrier Board the pinout type and is not connected for type 6.	NC		NC for Type 6 module
C58	PEG_RX2+	PCI Express Graphics (PEG) receive lane 2	DP-I		
C59	PEG_RX2-				
C60	GND	Power Ground	PWR GND		
C61	PEG_RX3+	PCI Express Graphics (PEG) receive lane 3	DP-I		
C62	PEG_RX3-				
C63	RSVD	Reserved for future use	NC		
C64	RSVD				
C65	PEG_RX4+	PCI Express Graphics (PEG) receive lane 4	DP-I		
C66	PEG_RX4-				
C67	RSDN	Rapid Shutdown Trigger Input	I-5		Used for rapid shutdown option
C68	PEG_RX5+	PCI Express Graphics (PEG) receive lane 5	DP-I		
C69	PEG_RX5-				
C70	GND	Power Ground	PWR GND		
C71	PEG_RX6+	PCI Express Graphics (PEG) receive lane 6	DP-I		
C72	PEG_RX6-				
C73	GND	Power Ground	PWR GND		
C74	PEG_RX7+	PCI Express Graphics(PEG) receive lane 7	DP-I		
C75	PEG_RX7-				
C76	GND	Power Ground	PWR GND		
C77	RSVD	Reserved for future use	NC		
C78	PEG_RX8+	PCI Express Graphics (PEG) receive lane 8	DP-I		
C79	PEG_RX8-				
C80	GND	Power Ground	PWR GND		
C81	PEG_RX9+	PCI Express Graphics(PEG) receive lane 9	DP-I		
C82	PEG_RX9-				
C83	RSVD	Reserved for future use	NC		
C84	GND	Power Ground	PWR GND		
C85	PEG_RX10+	PCI Express Graphics (PEG) receive lane 10	DP-I		
C86	PEG_RX10-				
C87	GND	Power Ground	PWR GND		
C88	PEG_RX11+	PCI Express Graphics (PEG) receive lane 11	DP-I		
C89	PEG_RX11-				
C90	GND	Power Ground	PWR GND		
C91	PEG_RX12+	PCI Express Graphics (PEG) receive lane 12	DP-I		
C92	PEG_RX12-				
C93	GND	Power Ground	PWR GND		
C94	PEG_RX13+	PCI Express Graphics (PEG) receive lane 13	DP-I		

Pin	COMe Signal	Description	Type	Termination	Comment
C95	PEG_RX13-				
C96	GND	Power Ground	PWR GND		
C97	RSVD	Reserved for future use	NC		
C98	PEG_RX14+	PCI Express Graphics (PEG) receive lane 14	DP-I		
C99	PEG_RX14-				
C100	GND	Power Ground	PWR GND		
C101	PEG_RX15+	PCI Express Graphics(PEG) receive lane 15	DP-I		
C102	PEG_RX15-				
C103	GND	Power Ground	PWR GND		
C104	VCC_12V	Main input voltage (4.75 V - 20 V)	PWR 4.75 V- 20 V		
C105	VCC_12V				
C106	VCC_12V				
C107	VCC_12V				
C108	VCC_12V				
C109	VCC_12V				
C110	GND	Power Ground	PWR GND		

+ and - Differential pair differentiator

5.2.4. Connector X1B Row D1 – D110

Table 29: Connector X1B Row D Pin Assignment (D1-D110)

Pin	COMe Signal	Description	Type	Termination	Comment
D1	GND	Power Ground	PWR GND		
D2	GND				
D3	USB_SSTX0-	USB SuperSpeed transmit pair 0	DP-0		
D4	USB_SSTX0+				
D5	GND	Power Ground	PWR GND		
D6	USB_SSTX1-	USB SuperSpeed transmit pair 1	DP-0		
D7	USB_SSTX1+				
D8	GND	Power Ground	PWR GND		
D9	USB_SSTX2-	USB SuperSpeed transmit pair 2	DP-0		
D10	USB_SSTX2+				
D11	GND	Power Ground	PWR GND		
D12	USB_SSTX3-	USB SuperSpeed transmit pair 3	DP-0		
D13	USB_SSTX3+				
D14	GND	Power Ground	PWR GND		
D15	DDI1_CTRLCLK_AUX+	DDI1 clock	I/O-3.3	PD 100 K Ω	
D16	DDI1_CTRLDATA_AUX-	DDI1 data	I/O-3.3	PU 100 K Ω , 3.3 V (50)	
D17	RSVD	Reserved for future use	NC		
D18	RSVD				
D19	PCIE_TX6+	PCI Express transmit lane 6	DP-0		
D20	PCIE_TX6-				
D21	GND	Power Ground	PWR GND		
D22	PCIE_TX7+	PCI Express transmit lane 7	DP-0		
D23	PCIE_TX7-				
D24	RSVD	Reserved for future use	NC		
D25	RSVD				
D26	DDI1_PAIR0+	DDI1 data pair 0	DP-0		
D27	DDI1_PAIR0-				
D28	RSVD	Reserved for future use	NC		
D29	DDI1_PAIR1+	DDI1 data pair 1	DP-0		
D30	DDI1_PAIR1-				
D31	GND	Power Ground	PWR GND		
D32	DDI1_PAIR2+	DDI1 data pair 2	DP-0		
D33	DDI1_PAIR2-				
D34	DDI1_DDC_AUX_SEL	DDI1 select	I-3.3	PD 1 M Ω	
D35	RSVD	Reserved for future use	NC		
D36	DDI1_PAIR3+	DDI1 data pair 3	DP-0		
D37	DDI1_PAIR3-				
D38	RSVD	Reserved for future use	NC		
D39	DDI2_PAIR0+	DDI2 data pair 0	DP-0		
D40	DDI2_PAIR0-				
D41	GND	Power Ground	PWR GND		
D42	DDI2_PAIR1+	DDI2 data pair 1	DP-0		
D43	DDI2_PAIR1-				
D44	DDI2_HPD	DDI2 Hotplug Detect	I-3.3	PD 100 K Ω	
D45	RSVD	Reserved for future use	NC		
D46	DDI2_PAIR2+	DDI2 data pair 2	DP-0		
D47	DDI2_PAIR2-				
D48	RSVD	Reserved for future use	NC		

Pin	COMe Signal	Description	Type	Termination	Comment
D49	DDI2_PAIR3+	DDI2 data pair 3	DP-0		
D50	DDI2_PAIR3-				
D51	GND	Power Ground	PWR GND		
D52	PEG_TX0+	PCI Express Graphics (PEG) transmit lane 0	DP-0		
D53	PEG_TX0-				
D54	PEG_LANE_RV#	PCI Express Graphics (PEG) Lane Reversal	NC		
D55	PEG_TX1+	PCI Express Graphics (PEG) transmit lane 1	DP-0		
D56	PEG_TX1-				
D57	TYPE2#	Indicates the Carrier Board the pinout type and is Ground for type 6 modules	PWR		GND for Type 6 module
D58	PEG_TX2+	PCI Express Graphics (PEG) transmit lane 2	DP-0		
D59	PEG_TX2-				
D60	GND	Power Ground	PWR GND		
D61	PEG_TX3+	PCI Express Graphics (PEG) transmit lane 3	DP-0		
D62	PEG_TX3-				
D63	RSVD	Reserved for future use	NC		
D64	RSVD				
D65	PEG_TX4+	PCI Express Graphics (PEG) transmit lane 4	DP-0		
D66	PEG_TX4-				
D67	GND	Power Ground	PWR GND		
D68	PEG_TX5+	PCI Express Graphics (PEG) transmit lane 5	DP-0		
D69	PEG_TX5-				
D70	GND	Power Ground	PWR GND		
D71	PEG_TX6+	PCI Express Graphics (PEG) transmit lane 6	DP-0		
D72	PEG_TX6-				
D73	GND	Power Ground	PWR GND		
D74	PEG_TX7+	PCI Express Graphics (PEG) transmit lane 7	DP-0		
D75	PEG_TX7-				
D76	GND	Power Ground	PWR GND		
D77	RSVD	Reserved for future use	NC		
D78	PEG_TX8+	PCI Express Graphics (PEG) transmit lane 8	DP-0		
D79	PEG_TX8-				
D80	GND	Power Ground	PWR GND		
D81	PEG_TX9+	PCI Express Graphics (PEG) transmit lane 9	DP-0		
D82	PEG_TX9-				
D83	RSVD	Reserved for future use	NC		
D84	GND	Power Ground	PWR GND		
D85	PEG_TX10+	PCI Express Graphics (PEG) transmit lane 10	DP-0		
D86	PEG_TX10-				
D87	GND	Power Ground	PWR GND		
D88	PEG_TX11+	PCI Express Graphics (PEG) transmit lane 11	DP-0		
D89	PEG_TX11-				
D90	GND	Power Ground	PWR GND		
D91	PEG_TX12+	PCI Express Graphics (PEG) transmit lane 12	DP-0		
D92	PEG_TX12-				
D93	GND	Power Ground	PWR GND		
D94	PEG_TX13+	PCI Express Graphics (PEG) transmit lane 13	DP-0		
D95	PEG_TX13-				
D96	GND	Power Ground	PWR GND		
D97	RSVD	Reserved for future use	NC		
D98	PEG_TX14+	PCI Express Graphics (PEG) transmit lane 14	DP-0		

Pin	COMe Signal	Description	Type	Termination	Comment
D99	PEG_TX14-				
D100	GND	Power Ground	PWR GND		
D101	PEG_TX15+	PCI Express Graphics (PEG) transmit lane 15	DP-0		
D102	PEG_TX15-				
D103	GND	Power Ground	PWR GND		
D104	VCC_12V	Main input voltage (4.75 V - 20 V)	PWR 4.75 V-20V		
D105	VCC_12V				
D106	VCC_12V				
D107	VCC_12V				
D108	VCC_12V				
D109	VCC_12V				
D110	GND	Power Ground	PWR GND		

+ and - Differential pair differentiator

6/ uEFI BIOS

6.1. Starting the uEFI BIOS

The COMe-bKL6 uses a Kontron-customized, pre-installed and configured version of Aptio® V uEFI BIOS based on the Unified Extensible Firmware Interface (uEFI) specification and the Intel® Platform Innovation Framework for EFI. This uEFI BIOS provides a variety of new and enhanced functions specifically tailored to the hardware features of the COMe-bKL6.



The BIOS version covered in this document might not be the latest version. The latest version might have certain differences to the BIOS options and features described in this chapter.



Register for the EMD Customer Section to get access to BIOS downloads and Product Change Notification (PCN) service.

The uEFI BIOS comes with a Setup program that provides quick and easy access to the individual function settings for control or modification of the uEFI BIOS configuration. The Setup program allows for access to various menus that provide functions or access to sub-menus with further specific functions of their own.

To start the uEFI BIOS Setup program, follow the steps below:

1. Power on the board.
2. Wait until the first characters appear on the screen (POST messages or splash screen).
3. Press the key.
4. If the uEFI BIOS is password-protected, a request for password will appear. Enter either the User Password or the Supervisor Password (see Security Setup Menu), press <RETURN>, and proceed with step 5.
5. A Setup menu appears.

The COMe-bKL6 uEFI BIOS Setup program uses a hot key navigation system. The hot key legend bar is located at the bottom of the Setup screens. The following table provides a list of navigation hot keys available in the legend bar.

Table 30: Navigation Hot Keys Available in the Legend Bar

Sub-screen	Description
<F1>	<F1> key invokes the General Help window
<->	<Minus> key selects the next lower value within a field
<+>	<Plus> key selects the next higher value within a field
<F2>	<F2> key loads previous values
<F3>	<F3> key loads optimized defaults
<F4>	<F4> key Saves and Exits
<←> or <↔>	<Left/Right> arrows selects major Setup menus on menu bar, for example, Main or Advanced
<↑> or <↓>	<Up/Down> arrows select fields in the current menu, for example, Setup function or sub-screen
<ESC>	<ESC> key exits a major Setup menu and enters the Exit Setup menu Pressing the <ESC> key in a sub-menu displays the next higher menu level
<RETURN>	<RETURN> key executes a command or selects a submenu

6.2. Setup Menus

The Setup utility features a selection bar at the top of the screen that lists the available menus:

- ▶ Main
- ▶ Advanced
- ▶ Chipset
- ▶ Security
- ▶ Boot
- ▶ Save & Exit

The currently active menu and the currently active uEFI BIOS Setup item are highlighted in white. Use the left and right arrow keys to select the Setup menus.

Each Setup menu provides two main frames. The left frame displays all available functions. Configurable functions are displayed in blue. Functions displayed in grey provide information about the status or the operational configuration. The right frame displays a Help window providing an explanation of the respective function.

6.2.1. Main Setup Menu

On entering the uEFI BIOS, the Setup program displays the Main Setup menu. This screen lists basic system information.

Figure 8: Main Setup Menu Initial Screens

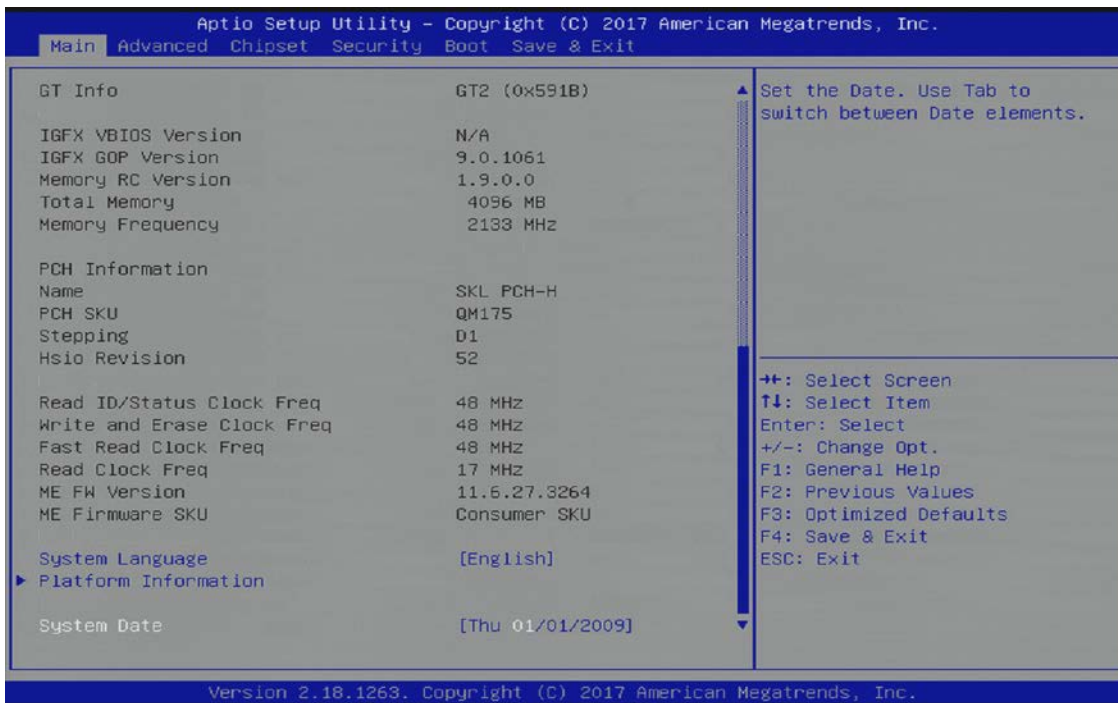
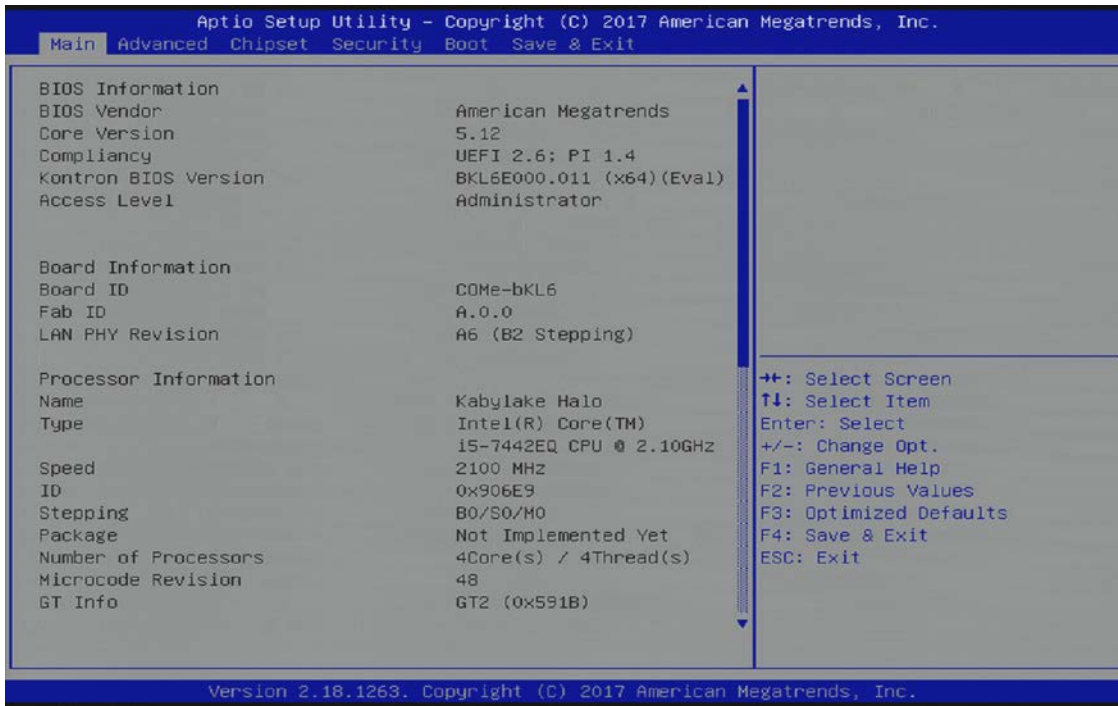

The following table shows Main sub-screens and functions, and describes the content. Default settings are in **bold**.

Table 31: Main Setup Menu Sub-screens

Sub-Screen	Description
Board Information>	Read only field <i>Displays Board Information:</i> Board ID, Fab ID, and LAN PHY revision
Processor Information>	Read only field <i>Displays Processor Information:</i> Name, Type, Speed, ID, Stepping, Number of Processors, Microcode Revision, and GT Info <i>Displays BIOS Version and Memory RC Version Information:</i> IGFX VBIOS Version, IGFX GOP Version, Memory RC Version Total Memory and Memory Frequency.
PCH Information>	Read only field <i>Displays PCH information:</i> Name, PCH SKU, Stepping, and Hsio Revision <i>Displays SPI Clock Information:</i> Read ID/Status Clock Frequency, Write and Erase Clock Frequency, and Fast Read Clock Frequency, Read Clock Frequency <i>Displays Firmware Information:</i> ME FWVersion and ME Firmware SKU
System Language>	Selects system default language [English]
Platform Information>	Read only field <i>Displays Module Information</i> Product Name, Revision, Serial # ,MAC Address, Boot Counter, and CPLD Rev Additional information for MAC Address The MAC address entry is the value used by the Ethernet controller and may contain the entry 'Inactive' - Ethernet chip is inactive. To activate the Ethernet chip set the following: Advanced > Network Stack Configuration > Network Stack > Enable 88:88:88:88:87:88 is a special pattern that will be filled in by the Ethernet firmware if there is no valid entry in the firmware block of the BIOS SPI (i.e. the MAC address has been overwritten during the last attempt to flash the system). For more information, see Chapter 6.5 Firmware Update.
System Date>	Displays the system date [Week Day mm/dd/yyyy]
System Time>	Displays the system time [hh:mm:ss]

6.2.2. Advanced Setup Menu

The Advanced Setup menu provides sub-screens and second level sub-screens with functions, for advanced configuration and Kontron specific configurations.

NOTICE

Setting items, on this screen, to incorrect values may cause system malfunctions.

Figure 9: Advanced Setup Menu Initial Screen

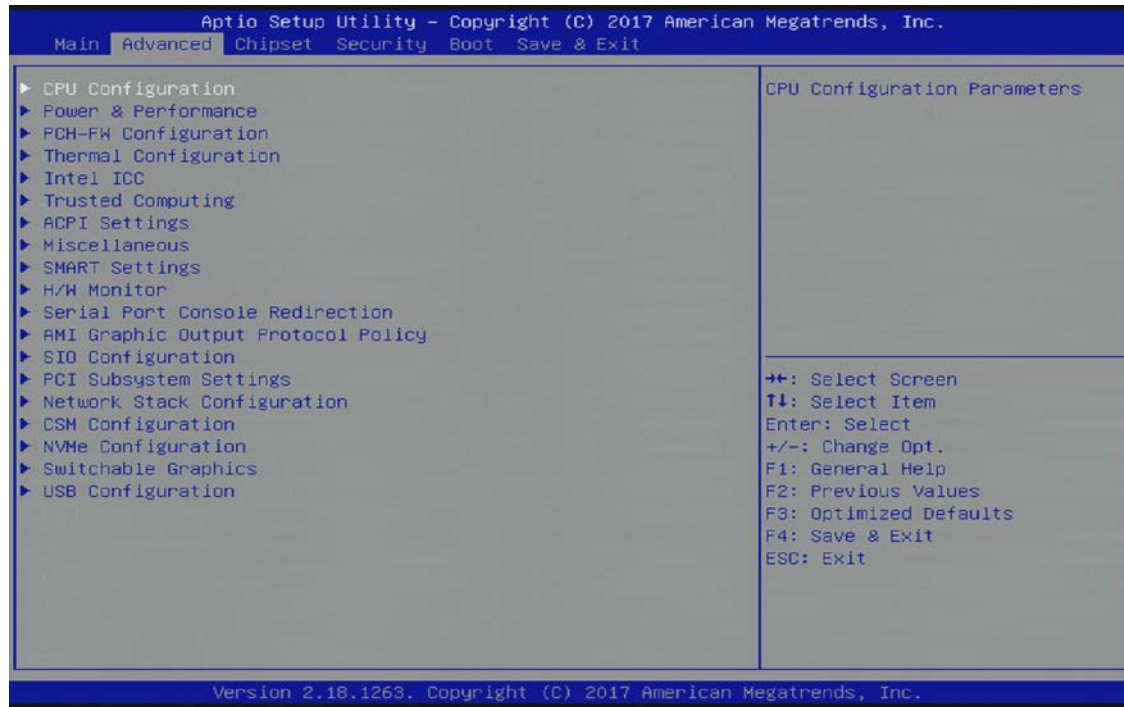

The following table shows the Advanced sub-screens and functions and described the content. Default settings are in **bold** and some functions include additional information.

Table 32: Advanced Setup menu Sub-screens and Functions

Sub-Screen	Function	Second level Sub-Screen / Description	
CPU Configuration>	Read only field <i>Displays CPU Information</i> Type, ID, Speed, L1 Data Cache, L1 Instruction Cache, L2 Cache, L3 Cache, L4 Cache, VMX, and SMX/TXT		
	Intel (VMX) Virtualization Technology>	Enables VMM to utilize additional hardware capabilities provided by Vanderpool Technology [Enabled, Disabled]	
	Active Processor Cores>	Displays number of cores to be enabled in each processor package [All, 1, 2, 3]	
Power and Performance>	CPU Power Management Control>	Boot Performance Mode>	Selects the performance state the BIOS sets before OS handoff [Max. Non-Turbo Perf., Max. Battery, Turbo Perf.]
		Intel® Speedstep™>	Allows support for more than two frequency ranges [Enabled, Disabled]

Sub-Screen	Function	Second level Sub-Screen / Description		
Power and Performance> (continued)	CPU Power management Control> (continued)	Intel® Speed Shift Technology>	Intel Speed Shift Technology support. Enable exposes CPPC v2 interface to allow for hardware controlled P-states. [Enabled, Disabled]	
		Turbo Mode>	Enables or disables Processor Turbo mode. Note: EMTTM must also be enabled. Auto means enabled unless the max. turbo ratio is bigger than 16-SKL A0 W/A. [Enabled, Disabled]	
		Config TDP Configurations >	Configurable TDP Boot Mode>	Selects the TDP Mode, where the deactivate option sets the MSR to nominal and MMIO to zero. [Nominal, Up, Down, Deactivate]
			Configurable TDP Lock>	[Disabled]
			CTDP BIOS Control>	[Disabled]
			Config, TDP levels>	States the number of TDP levels (3)
			ConfigTDP Turbo Activation Ratio>	Actual value for Turbo activation ratio (25 (unlocked))
			Power Limit 1>	Displays power limit value in milli Watts (mW). Note: Value will be rounded to the next 1/8 W. Zero means: no custom override. (15.0 W (MSR:25.0))
			Power Limit 2>	Displays power limit value in milli Watts (mW) (25.0 W (MSR: 15.0))
			Customer Settings Nominal Config TDP Nominal>	Ratio:26, TAR:25, PL1:15.0 W
			Power Limit 1>	Displays power limit value in mili Watts (mW). Note: . Value will be rounded to the next 1/8 W. Zero means: no custom override. (0)
			Power Limit 2>	Displays power limit value in milli Watts (mW). Note: . Value will be rounded to the next 1/8 W. Zero means: no custom override. (0)
			Power Limit 1 Time Window>	Sets the time window for power limit 1. [0]
			ConfigTDP Turbo Activation Ratio>	Custom value for Turbo activation ratio. This needs to be configured with valid values from LFM to Max Turbo. (0)

Sub-Screen	Function	Second level Sub-Screen / Description		
Power and Performance> (continued)	CPU Power management Control> (continued)	Config TDP Configurations > (continued)	Customer Settings Down ConfigTDP level 1>	Ratio:8, TAR:7, PL1:7.500 W
			Power Limit 1>	Displays power limit value in mili Watts (mW). Note: Value will be rounded to the next 1/8 W. Zero means: no custom override (0)
			Power Limit 2>	Displays power limit value in milli Watts (mW). Note: Value will be rounded to the next 1/8 W. Zero means: no custom override (0)
			Power Limit 1 Time Window>	Sets the time window for power limit 1 [0]
			Customer Settings UP ConfigTDP level 2>	Ratio:27, TAR:26, PL1:25.0 W
			Power Limit 1>	Displays power limit value in Watts. Note: . The value will be rounded to the next 1/8W. Zero means: no custom override. (0)
			Power Limit 2>	Displays power limit value in Watts Note: . The value will be rounded to the next 1/8W. Zero means: no custom override. (0)
			Power Limit 1 Time Window>	Sets the time window for power limit 1 [0]
			ConfigTDP Turbo Activation Ratio>	Custom value for Turbo activation ratio. This needs to be configured with valid values from LFM to Max Turbo. (0)
			<p>Additional Information</p> <p>The system allows for cTDP (=configurable thermal design power) to be set dynamically. This option is only available for processors that really support this feature. The menu item will disappear for any other CPU. The menu screen will also be different according to the options the CPU supports.</p> <p>Usually there are three levels to support: nominal, down and up. For each level the power limits, their time window and the activation ratio may be chosen. A value of zero for the activation ratio means that this level is not being used.</p> <p>NOTE: Take care to create valid configurations to avoid unexpected behavior of the system.</p>	

Sub-Screen	Function	Second level Sub-Screen / Description	
Power and Performance> (continued)	CPU Power management Control> (continued)	C-states>	Enables or disables CPU power management to allow CPU to enter C-Sates when not 100% utilized. [Enabled, Disabled]
		Enhanced C-state>	Enables or disables C1E. If enabled CPU switches to minimum speed when all cores enter C-state. [Enabled, Disabled]
		Packaged C-state Limit>	Maximum Package C-State limit setting. Default: leaves the factory default value. Auto initializes to deepest available package c-state limit. [Auto, CPU Default, C10, C9, C8, C7S, C7, C6, C3 , C2, C0/C1]
		Thermal Monitor>	Enable/disable thermal monitor [Enabled, Disabled]
	GT Power management Control>	RC6 (Render standby)>	Check to enable render standby support. [Enabled, Disabled]
		Maximum GT Frequency>	Maximum GT frequency limited by user. Choose from range 350 MHz (RPN) to 1000 MHz (RPO). Out of range values are clipped to the minimum and maximum range values above. [Default Max Frequency, 100 MHz, – 1200 MHz]
PCH-FW Configuration>	Read only fields ME FW Version, ME Firmware Mode, ME Firmware SKU, ME File System Integrity Value, ME Firmware Status 1, ME Firmware Status 2, NFC Support and ME State.		
	ME State>	If disabled, ME enters ME temporarily disabled mode. [Enabled, Disabled]	
	ME Unconfig ON RTC Clear>	If disabled, ME is not unconfigured on RTC clear. [Enabled, Disabled]	
	Comms Hub Support>	Support for Comms hub [Enabled, Disabled]	
	JHI Support>	Enables or disables Intel® DAL Host Interface Service (JHI) [Enabled, Disabled]	
	Core BIOS Done Message>	Enables or disables core BIOS done message sent to ME [Enabled, Disabled]	
	Firmware Update Configuration>	ME FW Image Re-Flash>	Enables or disables ME FW Image RE-Flash function [Enabled, Disabled]
Local FW Update>		Read only field [Enabled]	
Thermal Configuration>	CPU Thermal Configuration>	DTS SMM>	ACPI thermal management uses either HWM reported values when disabled or DTS SMM mechanism to obtain CPU temperatures values when enabled. Note: enabling DTS might deteriorate the system's real time behavior through handling the necessary SMMs. [Enabled, Disabled, Critical Temp Reporting]
		Tcc Activation Offset>	Displays the offset from the factory TCC (Thermal Control Circuit) activation temperature. Note: this values is subtracted from the TCC threshold, i.e. '0' means maximum allowed temperature.

Sub-Screen	Function	Second level Sub-Screen / Description	
Thermal Configuration> (continued)	CPU Thermal Configuration> (continued)		[0]
		ACPI T-states>	ACPI T-States [Enabled , Disabled]
	Platform Thermal Configuration>	Automatic Thermal Reporting>	Enable -configures ACPI thresholds according to INTEL thermal management settings and disable allows for manual configuration. [Enabled, Disabled]
		Critical Trip Point>	Controls the temperature of the ACPI Critical Trip Point at which OS shuts off the system. Note: The plan of record (POR) for Intel® Mobile Processors is 119°. [127°C, 119°C , 111°C, 103°C, 100°C, 95°C, 87°C, 79°C, 71°C, 63°C, 55°C, 47°C, 39°C, 31°C, 23°C, 15°C]
		Passive Trip Point>	Controls temperature of ACPI Passive Trip Point at which OS begins to throttle the processor. [119°C, 111°C, 103°C, 100°C, 95°C , 87°C, 79°C, 71°C, 63°C, 55°C, 47°C, 39°C, 31°C, 23°C, 15°C, Disabled]
		Passive TC1 Value>	Sets TC1 values for ACPI passive cooling formula (Range: 1-16) [1]
		Passive TC2 Value>	Sets TC2 values for ACPI passive cooling formula (Range: 1-16) [5]
		Passive TSP Value>	Sets TSP value for ACPI passive cooling formula. TSP value represents how often OS reads the temperature when passive cooling is enabled. (Range: 2-32) [10]
		Passive Trip Points>	Passive Trip Points [Enabled, Disabled]
		Critical Trip Points>	Critical Trip Points [Enabled, Disabled]
Intel ICC>	ICC/OC Watchdog Timer>	Enabling exposes the ICC/OC watchdog timer to OS as ACPI device. BIOS always uses WDT HW when changing clock setting. [Enabled, Disabled]	
	ICC Locks After EOP>	Read only field Specifies the ICC registers to write to, after end of post. [Default]	
	ICC Profile>	Read only field Specified the ICC profile [1]	
Trusted Computing>	Security Device Support>	Enables or disables BIOS support for security device. Operating system will not show security device. TCG EFI protocol and INT1A interface are not available. [Enabled, Disabled]	
	Active PCR Banks>	Read only field Displays active PCR Banks [SHA-1,SHA256]	
	Available PCR Banks>	Read only field Displays available PCR Banks [SHA-1,SHA256]	

Sub-Screen	Function	Second level Sub-Screen / Description	
Trusted Computing> (continued)	SHA-1 PCR Bank>	SHA-1 PCR Bank [Enabled, Disabled]	
	SHA256 PCR Bank>	SHA256 PCR Bank [Enabled, Disabled]	
	Pending Operation>	Schedules operation for Security Device Note: Computer reboots on restart in order to change the state of the security device. [None, TPM Clear]	
	Platform Hierarchy>	Platform Hierarchy [Enabled, Disabled]	
	Storage Hierarchy>	Storage Hierarchy [Enabled, Disabled]	
	Endorsement Hierarchy>	Endorsement Hierarchy [Enabled, Disabled]	
	TPM2.0 UEFI Spec Version>	Selects TCG2 Spec Version support. TCG_1_2 is compatible mode for Win8/Win10 and TCG_2 supports TCG2 protocol + event format Win 10 or later. [TCG_1_2, TCG_2]	
	Physical Presence Spec Version>	Select to tell OS to support either PPI Spec 1.2 or 1.3 Note: Some HCK tests might not support 1.3. [1.2, 1.3]	
	TPM 20 InterfaceType>	Read only field [TIS]	
Device Select>	BIOS support for security devices. Auto supports both TPM 1.2 and TPM 2.0. TPM 1.2 restricts support to TPM 1.2 devices and TPM 2.0 restricts support to TPM 2.0. devices. [TPM 1.2, TPM 2.0, Auto]		
ACPI settings>	Enable ACPI Auto Configuration>	Enables or disables BIOS ACPI auto configuration. If enabled, the system uses generic ACPI settings that may not fit the system best. [Enabled, Disabled]	
	Enable Hibernation>	Enables or disables systems ability to hibernate (OS/S4 Sleep State) This option may not be effective with some operating systems. [Enabled, Disabled]	
	ACPI Sleep State>	Selects highest ACPI sleep state that the system enters when SUSPEND button is pressed [Suspend Disabled, S3 (Suspend to Ram)]	
	Lock Legacy Resources>	Enables or disable lock of legacy resources [Enabled, Disabled]	
	S3 Video Repost>	Enables or disables S3 video repost [Enabled, Disabled]	
Miscellaneous>	Watchdog>	Auto Reload>	Enables automatic reload of watchdog timers on timeout [Enabled, Disabled]
		Global Lock>	Enable sets all Watchdog registers (except for WD_KICK) to read only, until board is reset. [Enabled, Disabled]
		Stage 1 Mode>	Selects action for this Watchdog stage [Disabled, Reset, NMI, SCI, Delay, WDT Signal only]

Sub-Screen	Function	Second level Sub-Screen / Description
Miscellaneous> (continued)	Additional Information two-staged watchdog Programmable stages to trigger different actions - If one stage is disabled, then the next stage is also disabled. Common actions for a watchdog trigger events 'Delay', 'Reset' and 'Watchdog signal only' CPLD code allows for triggering NMI or SCI. This needs programming of a predefined action inside the BIOS and therefore can only be used in a customized BIOS solution. Timeouts that can be set to eight different fixed values between 1 second and 30 minutes.	
	Reset Button Behavior>	Selects reset button behavior [Chipset Reset , Power cycle]
	I2C Speed>	Selects internal I2C bus speed between (1 kHz and 400 kHz) [200 kHz]
	On-board I2C Mode>	Keep 'Multimaster' setting unless otherwise noted [MultiMaster , BusClear]
	Manufacturing Mode>	Read only field [Disabled]
	LID Switch Mode>	Shows or hides Lid Switch Inside ACPI OS. The default setting is disabled. [Disabled , Active normal, Active inverse]
	Sleep Button Mode>	Shows or hides Sleep Button inside ACPI OS. Default setting is disabled. [Enabled, Disabled]
	ACPI Temperature Polling>	Sets mode used for temperature polling through the OSPM (0 is disabled and 1 enabled) [Enabled , Disabled]
	TZ00 Temperature Polling>	Displays the time interval in seconds, between two attempts to measure temperature in ACPI thermal zone 00 (Ambient temperature) [30]
	TZ01 Temperature Polling>	Displays the time interval in seconds, between two attempts to measure temperature in ACPI thermal zone 01 (CPU temperature) [30]
	PCI ExpressCard 0>	Controls PCIe port for ExpressCard support If not used, keep in the disabled state. [Port 1, Port 2, Port 3, Port4, Disabled]
	PCI ExpressCard 1>	Controls PCIe port for ExpressCard support If not used, keep in the disabled state. [Port 1, Port 2, Port 3, Port4, Disabled]
	SMART Settings>	Smart Self Test> Run Smart Self Test on all HDDs during POST [Enabled, Disabled]
H/W Monitor>	CPU Temperature>	Read only field Displays CPU temperature in °C
	Module Temperate>	Read only field Displays module temperature in °C
	CPU Fan – Fan Control>	Sets Fan Control mode for CPU fan Disable – stops fan. Manual – manually sets the fan Auto – Hardware monitor controls cooling, similar to ACPI based 'Active Cooling', without producing a software load to the system. [Disable, Manual, Auto]

Sub-Screen	Function	Second level Sub-Screen / Description
H/W Monitor> (continued)	CPU Fan – Fan Pulse>	Displays number of pulses fan produces during 1 revolution. (Range: 1-4) [2]
	CPU Fan – Fan Trip Point>	Displays temperature at which the fan accelerates. (Range: 20°C – 80°) [50]
	CPU Fan – Trip Point Speed>	Displays Fan speed at trip point in %. Minimum value is 30 %. Fan always runs at 100 % at TJmax (-10°C). [50]
	CPU Fan – Ref. Temperature>	Determines temperature source used for automatic fan control [PCH Temperature, Module Temperature, CPU Temperature]
	External Fan- Fan Control>	Sets Fan Control mode for external fan Disable - stops the fan Manual – manually set the fan Auto - hardware monitor controls cooling, similar to ACPI based 'Active Cooling', without producing a software load to the system. [Disable, Manual, Auto]
	External Fan- Fan Pulse>	Displays number of pulse fan produces during 1 revolution (Range: 1-4) [2]
	External Fan- Fan Trip point>	Displays temperature at which fan accelerates. (Range: 20°C to 80°C) [50]
	External Fan- Trip Point Speed>	Displays Fan speed at trip point in %. Minimum value is 30% Fan always runs at 100% at TJmax (-10°C) [50]
	External Fan Reference Temperature>	Determines temperature source used for automatic fan control [PCH Temperature, Module Temperature, CPU Temperature]
	Additional information External Fan	
	An external fan can be connected to baseboard. The external fan's control lines are routed via the COMe connector.	
	5.0V Standby>	Read only field Displays standby voltage
	Batt Volt. at COMe Pin>	Read only field Displays battery voltage at COMe pin
Widerange Vcc>	Read only field Displays wide range VCC	
Serial Port Console Redirection>	COM0 Console Redirection>	Console redirection via COMe module's COM1. If redirection is enabled then the port settings such as Terminal type, Bits per second, Data bits, Parity etc. can be adjusted here. Note: on-module COM ports do not support flow control. [Enabled, Disabled]
	COM1 Console Redirection>	Console redirection via COMe module's COM2. If redirection is enabled, then the port settings such as Terminal type, Bits per second, Data bits, Parity etc. can be adjusted here. Note: On-module COM ports do not support flow control. [Enabled, Disabled]

Sub-Screen	Function	Second level Sub-Screen / Description	
Serial Port Console Redirection> (continued)	COM2 Console Redirection>	Console redirection via COM3, available with an optional Winbond SuperIO on the baseboard. (Default is disabled) If redirection is enabled, then the port settings such as Terminal type, Bits per second, Data bits, Parity etc. can be adjusted here. [Enabled, Disabled]	
	COM3 Console Redirection Settings>	Console redirection via COM4, available with an optional Winbond SuperIO on the baseboard. (Default is disabled) If redirection is enabled, then the port settings such as Terminal type, Bits per second, Data bits, Parity etc. can be adjusted in 'Settings'. [Enabled, Disabled]	
	Legacy Console Redirection>	Legacy Serial Redirection Port>	Selects a COM port to display redirection of legacy OS and legacy OPRM messages [COM0, COM1, COM2, COM3]
	Serial Port for Out-of-Band Management / Windows EMS Console Redirection>	Console redirection [Enabled, Disabled]	
SIO Configuration>	Serial Port 0>	Use This Device>	Enables or disables the use of this logical device. [Enabled, Disabled]
		Logical Device Settings: Current>	Read only field IO=3F8h; IRQ=4
		Logical Device Settings: Possible>	Allows the user to change the device's resource settings. New settings are reflected on the Setup page after system restarts. [Use Automatic Settings, IO=3F8h; IRQ=4, IO=3F8h; IRQ=3,4,5,7,9,10,11,1, IO=2F8h; IRQ=3,4,5,7,9,10,11,12, IO=3E8h; IRQ=3,4,5,7,9,10,11,12, IO=2E8h; IRQ=3,4,5,7,9,10,11,12]
	Serial Port 1>	Use This Device>	Enables or disables the use of this logical device. [Enabled, Disabled]
		Logical Device Settings: Current>	Read only field IO=2F8h; IRQ=3
		Logical device settings: Possible>	Allows the user to change the device's resource settings. New settings are reflected on the Setup page after system restart. [Use Automatic Settings, IO=2F8h; IRQ=3, IO=3F8h; IRQ=3,4,5,7,9,10,11,1, IO=2F8h; IRQ=3,4,5,7,9,10,11,12, IO=3E8h; IRQ=3,4,5,7,9,10,11,12, IO=2E8h; IRQ=3,4,5,7,9,10,11,12]

Sub-Screen	Function	Second level Sub-Screen / Description		
SIO Configuration> (continued)	<p>Additional Information SIO:</p> <p>If they exist, additional interfaces such as Serial Port 2, Serial Port 3 and Parallel Port will be included within the SIO Configuration setup page.</p> <p>The SIO Configuration menu enables all available serial interfaces to be configured. The module-based serial interfaces always appear as COM1 and COM2. COM 1 and COM 2 can be treated as 16550-compatible legacy COM interfaces at the standard I/O addresses and are based in the on-module CPLD. Note: Hardware flow control is not supported.</p> <p>Optionally, If the baseboard contains an activated SuperIO of the type Winbond 83627, then its serial interfaces are added to the system as COM3 and COM4. COM3 and COM4 IRQ and I/O addresses are configurable in this menu, too.</p> <p>Although the chipset internal COMs are not supported due to technical constraints their driver must be installed. Installing the driver does not mean that these serial interfaces are useable.</p> <p>Warning: Logical Devices state on the left side of the control reflects the current logical device state. Changes made during the setup session are shown after restarting the system.</p>			
PCI Subsystem Settings>	PCI Latency Timer>	Displays value to be programmed into the PCI latency timer register [32 , 64, 96, 128, 160, 192, 224, 248]		
	PCI-X Latency Timer>	Displays value to be programmed into the PCI latency timer register [32, 64 , 96, 128, 160, 192, 224, 248]		
	VGA Palette Snoop>	Enables or disables VGA palette register snooping [Enabled, Disabled]		
	PERR# Generation>	Enables or disables PCI device to generate PERR# [Enabled, Disabled]		
	SERR# Generation>	Enables or disables PCI device to generate SERR# [Enabled, Disabled]		
	Above 4G Decoding>	Enables or disables decoding in Address Space above '4G' for 64 bit capable devices. Note: Only if system supports 64 bit PCI decoding. [Enabled, Disabled]		
	PCI Hot-Plug Settings>	BIOS Hot Plug Support>	Enable – allows BIOS built in hot-plug support Note: Use if OS does not support PCIe and SHPC hot-plug natively. [Enabled , Disabled]	
		PCI Buses Padding>	Padd PCI Buses behind the bridge for hot-plug [Disabled, 1 , 2, 3, 4, 5]	
		I/O Resources Padding>	Padd PCI resources behind the bridge for hot-plug [Disabled, 4 k , 8 k, 16 k, 32 k]	
		MMIO 32 bit Resources Padding>	Padd PCI MMIO 32 bit resources behind the bridge for hot-plug. [Disabled, 1 M, 2 M, 4 M, 8 M, 16, M , 32 M, 64 M, 128 M]	
PFMMIO 32 bit Resources Padding>		Padd PCI MMIO 32 bit pre-fetchable resources behind the bridge for hot-plug. [Disabled, 1 M, 2 M, 4 M, 8 M, 16, M , 32 M, 64 M, 128 M]		
Network Stack Configuration>	Network Stack>	If UEFI network stack is enabled, the Ethernet chip is active. [Enabled, Disabled]		
CSM Configuration>	CSM Support>	Enables or disables CSM Support If enabled, the CSM details can be changed. Below 'Option ROM Execution' are 'Network', 'Storage', 'Video' and 'Other PCI devices'.		

Sub-Screen	Function	Second level Sub-Screen / Description
CSM Configuration> (continued)	CSM Support> (continued)	Note: 'Network' must be changed to 'Legacy' for legacy boot. (Default setting is 'Do not launch'). [Enabled, Disabled]
	Additional Information CSM: Compatibility Support Module (CSM) configuration is important for legacy operating systems. By default, CSM is disabled for modern OS such as Windows 8, 10 and Linux. If a legacy OS is used or a Windows or Linux system is run in legacy mode then this menu allows for detailed option settings. Note, a change in settings only come into effect after the next restart. Therefore, to be able to use the actualized settings, it is recommended to save and exit the setup and re-enter. The 'Optional ROM Execution' settings requires special care. Any OS using an INT10 based display output needs the 'Video' option set to 'Legacy', in the same way that PXE boot needs 'Network' 'Optional ROM' to be set to 'Legacy'.	
NVMe Configuration>	Read only field Acts as a message showing NVMe (Non-Volatile memory PCIe) devices connected to the system. [NO NVME Device Found]	
Switchable Graphics>	SG Mode Select>	Read only field Switchable graphics selection [Muxless]
USB Configuration>	Read only fields USB Configuration, UBS Module Version, USB Controllers, and USB devices	
	Legacy USB Support>	Enable- Supports legacy USB Auto- disables legacy support, if no USB devices are connected Disable-keeps USB devices available for EFI applications only [Enabled , Disabled, Auto]
	XHCI Hand-off>	XHCI ownership change claimed by XHCI driver. Note: this is a work around for OS(s) without XHCI hand-off support. [Enabled , Disabled]
	USB Mass Storage Driver Support>	Enables or disables USB mass storage driver support [Enabled , Disabled]
	Port 60/64 Emulation>	Enables I/O port 60h/64h emulation support Note: Enable for USB keyboard legacy support for non-USB aware OS(s). [Enabled, Disabled]
	USB Transfer Time-out>	Displays timeout value for control, bulk and interrupt transfers [1 sec, 5 sec, 10 sec, 20 sec]
	Device Reset Time-out>	Displays USB mass storage device start unit command time-out [10 sec, 20 sec , 30 sec, 40 sec]
	Device Power-up Delay>	Displays maximum time taken for the device to report itself to the host properly. Auto uses the default :root port 100 ms /hub port delay from hub port descriptor. [Auto , Manual]

6.2.3. Chipset Setup Menu

On entering the Chipset Setup menu, the screen lists two sub-screen options:

- ▶ System Agent (previously Northbridge)
- ▶ PCH-IO (previously Southbridge)

6.2.3.1. Chipset > System Agent Configuration

Figure 10: System Agent Configuration Menu Initial Screen

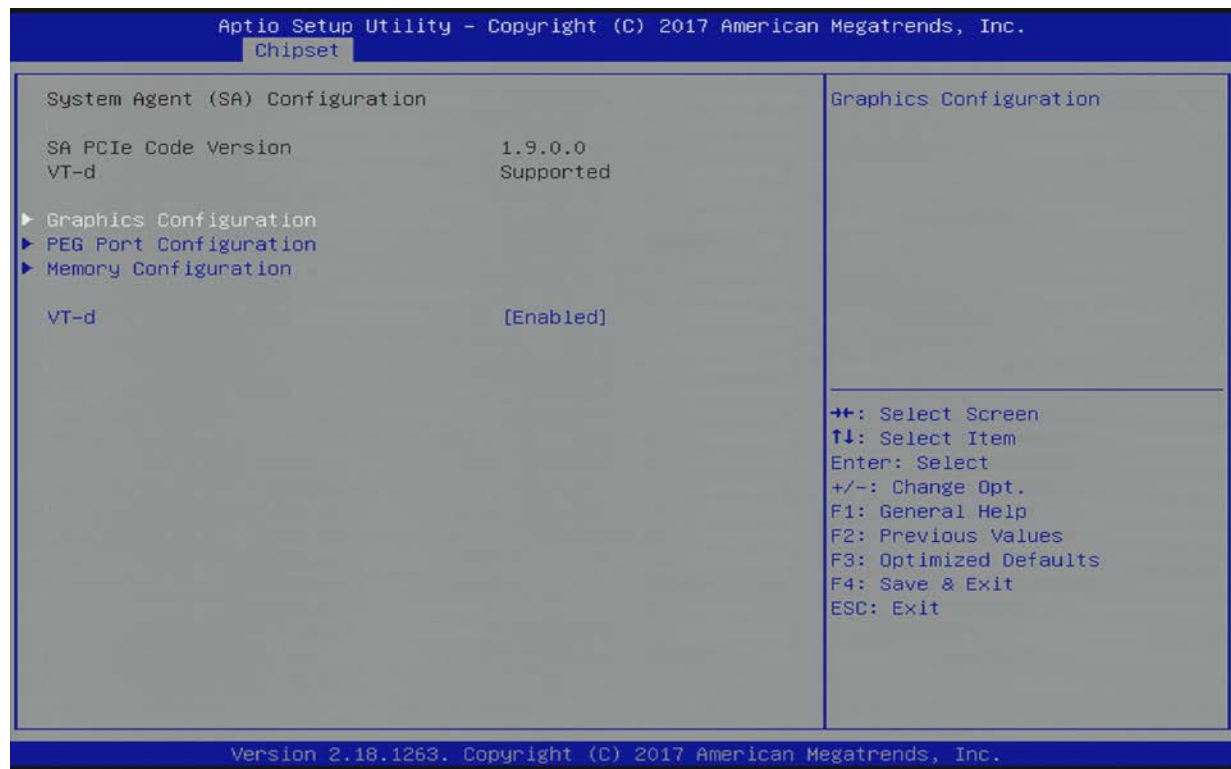

The following table shows System Agent Configuration sub-screens and functions, and describes the content. Default settings are in **bold**.

Table 33: Chipset Set > System Agent Configuration Sub-screens and Functions

Function	Second level Sub-Screen / Description	
SA PCIe Code Version>	Read only field States versions of the code	
VT-d >	Read only field States if virtualization is supported	
Graphics Configuration>	Graphics Turbo IMON Current>	Displays supported Graphics turbo IMON current values range: (14-31) [31]
	Skip Scanned for External Gfx Card>	If enabled, no scan is made for external Gfx cards on PEG or PCH PCIE ports. Default setting is disabled. [Enabled, Disabled]
	Internal Graphics>	To keep IGFX enabled, based on setup options [Auto] , Enabled, Disabled]

Function	Second level Sub-Screen / Description	
Graphics Configuration > (continued)	GTT Size>	Select GTT size [2 MB, 4 MB, 8 MB]
	Aperture Size>	Select Aperture size. Note: above 4GB MMIO, BIOS assignment is automatically enabled when selecting 2048 MB aperture. Note:To use this feature disable CSM support. [128 MB, 256 MB , 512 MB, 1024 MB, 2048 MB]
	DVMT Pre-Allocated>	Select DVMT 5.0 pre-allocated (fixed) graphics memory size used by internal graphics device. [0 M, 32 M , 64 M, 4 M, 8 M, 12 M, 16 M 20 M 24 M, 28 M 32 M/F7, 36 M, 40 M, 44 M, 48 M, 52 M 56 M 60 M]
	DVMT Total Gfx Mem>	Select DVMT 5.0 graphics memory size used by internal graphics device [256M , 128M, MAX.]
	Gfx Low Power Mode>	Used for SFF only [Enabled , Disabled]
	VDD Enable>	Enables or disables VDD forcing in BIOS [Enabled , Disabled]
	HDCP Support>	HDCP provisioning BIOS support [Enabled , Disabled]
	Algorithm>	HDCP re-encryption flow [One-time , Periodic]
	PM Support>	Enables or disables PM support [Enabled , Disabled]
	PAVP Enable>	Enables or disables PAVP [Enabled , Disabled]
	Cdynmax Clamping Enable>	Enables or disabled cdynmax clamping [Enabled , Disabled]
	Cd Clock Frequency>	Select highest Cd clock frequency supported by platform [337.5 MHz, 450 MHz, 540 MHz, 675 MHz]
	IGD Configuration>	Read Only field LVS EEPROM data, Data format, Resolution; Colour depth, and Channel count. Note : Optionally visible if a LVS display is use in auto mode or if LFP has been set manually
		IGD- Boot Type>
	LFP Panel Type>	Selects panel type connected to eDP port as native eDP or LVDS via a bridge. Note: Depends on hardware option of the module. [LVDS , eDP]
	Backlight Control>	Backlight control settings options [None external, PWM , PWM Inverted, I2C]

Function	Second level Sub-Screen / Description			
Graphics Configuration > (continued)	IGD Configuration> (continued)	PWM Frequency>	Set LCD backlight PWM frequency [200 Hz , 400 Hz, 1 kHz, 2 kHz, 4 kHz, 8kHz, 20 kHz, 40 KHz]	
		Backlight Value>	Sets LCD backlight brightness range: (0-255) [128]	
		LVDS Clock Center Spreading>	Selects the LVDS clock frequency center spreading depth [No Spreading , 0.5%, 1.0%, 1.5%, 2.0%, 2.5 %]	
		EFP1 Type>	Integrated HDMI/DisplayPort configuration with external connectors [DisplayPort Only, DP with HDMI/DVI , HDMI/DVI]	
		EFP1 LSPCON>	HDMI2.0 feature Level shifter/protocol converter [Enabled, Disabled]	
		EFP2 Type>	Integrated HDMI/DisplayPort configuration with external connectors [DisplayPort Only, DP with HDMI/DVI , HDMI/DVI]	
		EFP2 LSPCON>	HDMI2.0 feature Level shifter/protocol converter [Enabled, Disabled]	
		EFP3 Type>	Integrated HDMI/DisplayPort configuration with external connectors [DisplayPort Only, DP with HDMI/DVI , HDMI/DVI]	
		EFP3 LSPCON>	HDMI2.0 feature Level shifter/protocol converter [Enabled, Disabled]	
		Mode Persistence>	Mode persistence [Enabled, Disabled]	
		Center Mode>	Selects the display device that should be centered [Enabled, Disabled]	
		PEG Port Configuration>	PEG Configuration>	Sets PEG configuration in both normal and reversed modes [1x16 , 1x16 rev, 2x8, 2x8 rev, 1x8+2x4, 1x8+2x4 rev]
PEG 0:1:0 – PEG0 or PEG 0:1:1 – PEG1 or PEG 0:1:2 – PEG2	Enable Root Port>		Enables or disables the root port [Enabled, Disabled, Auto]	
	Max Link Speed>		Configure PEG #:#:# maximum speed [Auto , Gen1, Gen2, Gen3]	
	PEG0 Slot Power Limit Value>		Sets power supply upper limit by slot. Power limit (watts) is calculated by multiplying this value by the Slot Power Limit scale. (0 - 255) [75]	
	PEG0 Slot Power Limit Scale>		Selects scale used for the slot power limit value [1.0x , 0.1x, 0.01x, 0.001X]	
	PEG0 Physical Slot Number>		Sets the port's slot number. This number must be globally unique within the chassis (0 - 8191).	

Function	Second level Sub-Screen / Description		
PEG Port Configuration> (continued)	Peg Port Feature Configuration>	Detect Non-Compliance device>	Detects non-compliance PCIe device in PEG [Enabled, Disabled]
	PCIe Spread Spectrum Clocking>	Allows spreader clocking to be disabled for compliance testing [Enabled , Disabled]	
Memory Configuration>	Read only field Memory RC version, Memory frequency, Memory timings (tCL, tRCD, tRP, tRAS), Channel 0 slot 0, Size, Channel 0 slot 1, Channel 1 slot 0 and Channel 1, slot 1.		
	ECC Support>	Enables or disables DDR ECC support [Enabled , Disabled]	
	Max TOLUD>	Sets the maximum TOLUD value. Dynamic assignment adjusts TOLUD automatically, based on largest MMIO length of the installed graphic controller. [Dynamic , 1 GB, 1.25 GB, 1.5 GB, 1.75 GB, 2 GB, 2.25 GB, 2.5 GB, 2.75 GB, 3 GB, 3.25 GB, 3.5 GB]	
VT-d>	VT-d capability [Enabled /Disabled]		

6.2.3.2. Chipset > PCH-IO Configuration

Figure 11: PCH-IO Configuration Menu Initial Screen

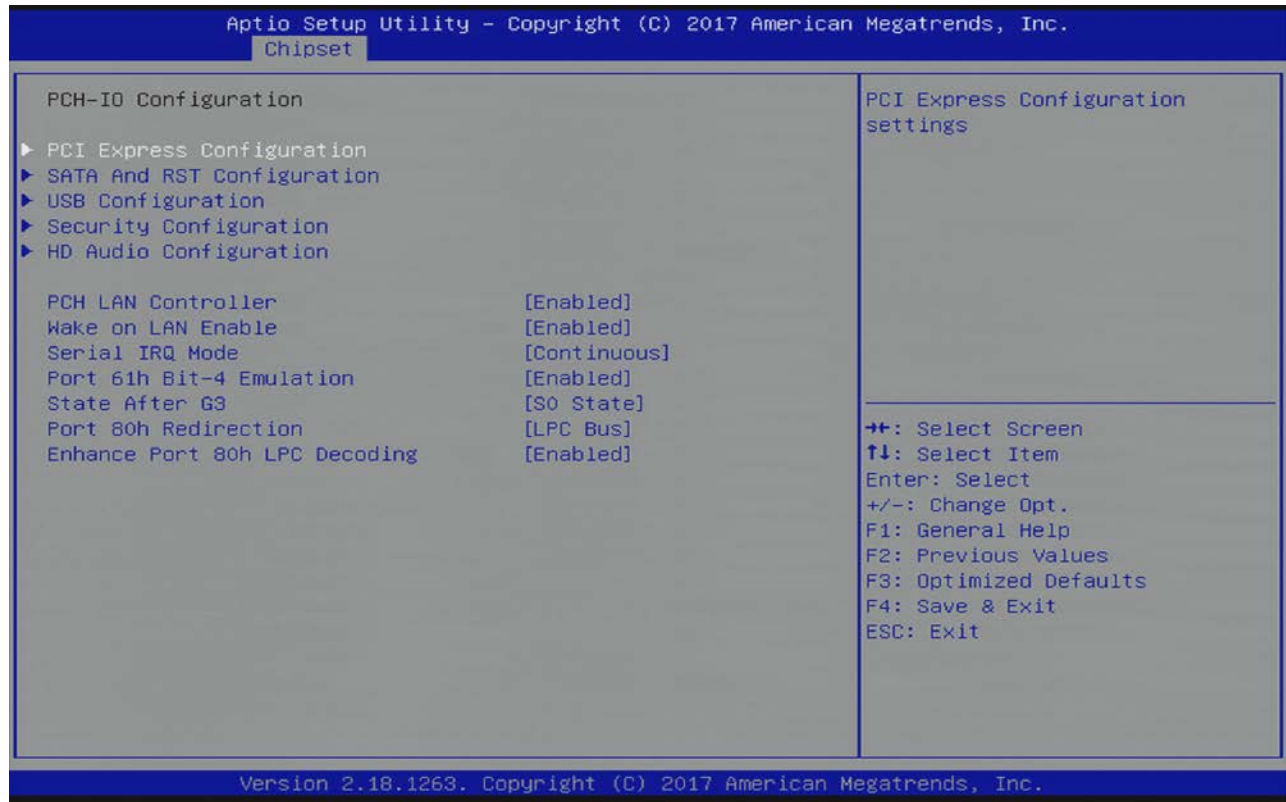

The following table shows the PCH-IO sub-screens and functions, and describes the content. Default settings are in **bold** and some functions include additional information.

Table 34: Chipset Set > PCH-IO Configuration Sub-screens and Functions

Function	Second level Sub-Screen / Description	
PCI Express Configuration>	PCI Express Clock Gating>	PCI Express clock gating for each root port [Enabled , Disabled]
	Legacy IO Low Latency>	Enables low latency of legacy I/O as some systems require lower I/O latency irrespective of power. This is a tradeoff between power and I/O latency. [Enabled, Disabled]
	DMI Link ASPM Control>	Control of Active State Power Management on SA side of DMI link [Enabled, Disabled]
	PCIe Port Assigned toLAN>	Read Only file This port is always 5. [5]
	Port8xh Decode>	PCI express port 8xh decode [Enabled, Disabled]
	PCI Express Clock Gating>	PCI Express clock gating for each root port [Enabled, Disabled]

Function	Second level Sub-Screen / Description		
PCI Express Configuration> (continued)	Compliance Test Mode>	Enable when using compliance load board [Enabled, Disabled]	
	PCIe-USB Glitch W/A	For bad USB device(s) connected behind PCIE/PEG Port [Enabled, Disabled]	
	PCIe Function Swap	If disables, prevents PCIE root port function swap. If any function other than 0 th is enabled, 0 th will become visible. [Enabled, Disabled]	
	PCI Root Port 1 (COMe PCIe#4)> or PCI Root Port 2 (COMe PCIe#5)> or PCI Root Port 3 (COMe PCIe#6)> or PCI Root Port 4 (COMe PCIe#7)> or PCI Root Port 9 (COMe PCIe#0)> or PCI Root Port 10 (COMe PCIe#1)> or PCI Root Port 11 (COMe PCIe#2)> or PCI Root Port 12 (COMe PCIe#3)>	PCIe Root port[#]>	Controls the PCI Express root ports [1, 2, 3, 4, 9, 10, 11, 12] Note: Uses the CPU enumeration [Enabled, Disabled]
		Topology>	Identifies the SATA Topology [Unknown, x1, x4, SATA Express, M.2.]
		ASPM>	Sets ASPM level [Auto, L0sL1, L1, L0s, Disabled]
		L1 Substates>	PCI Express L1 substrates settings. [Disabled, L1.1, L1.2, L1.1 & L1.2]
		Gen3 Eq Phase3 method>	PCIe Gen3 Equalization phase 3 method [Hardware, Static Coeff., Software Search]
		UPTP>	Upstream Port Transmitter Preset [5]
		DPTP>	Downstream Port Transmitter Preset [7]
		ACS>	Access Control Service Extended Capability [Enabled, Disabled]
		URR>	PCI Express unsupported request reporting [Enabled, Disabled]
		FER>	PCI Express device fatal error reporting [Enabled, Disabled]
		NFER>	PCI Express device non-fatal error reporting [Enabled, Disabled]
		CER>	PCI Express device correction error reporting [Enabled, Disabled]
		CT0>	PCIe Express Completion timer (T0) [Enabled, Disabled]
		SEFE>	Root PCI Express System Error on Fatal Error [Enabled, Disabled]
		SENF>	Root PCI Express System Error on non-Fatal Error [Enabled, Disabled]
		SECE>	Root PCI Express System Error on correctable error [Enabled, Disabled]

Function	Second level Sub-Screen / Description		
PCI Express Configuration> (continued)	PCI Root Port 1 (COMe PCIe#4)> or PCI Root Port 2 (COMe PCIe#5)> or PCI Root Port 3 (COMe PCIe#6)> or PCI Root Port 4 (COMe PCIe#7)> or PCI Root Port 9 (COMe PCIe#0)> or PCI Root Port 10 (COMe PCIe#1)> or PCI Root Port 11 (COMe PCIe#2)> or PCI Root Port 12 (COMe PCIe#3) (continued)	PME SCI>	PCI Express PME SCI [Enabled, Disabled]
		Hot Plug>	PCI Express hot plug [Enabled, Disabled]
		Advanced Error reporting>	Advanced –error reporting [Enabled, Disabled]
		PCIe Speed>	Configures PCIe speed [Auto, Gen 1, Gen 2, Gen3]
		Transmitter Half Swing>	Transmitter half swing [Enabled, Disabled]
		Detector Timeout>	Number of mSeconds the reference code waits for a link to exit detect state for enabled ports before assuming there is no device and potentially disabling the port.
		Extra Bus Reserved>	Extra bus reserved (0-7) for bridges behind this root bridge. [0]
		Reserved Memory>	Reserved memory for this root bridge Range: (1MB-20MB) [10]
		Reserved I/O>	Reserved IO for this root bridge Range: (4 k, 8 k, 16 k, 20 k) [4]
		PCH PCIe1 LTR>	PCH PCIe latency reporting [Enabled, Disabled]
		Snoop latency Override>	Snoop latency override or Non Snoop Override for PCH PCIe. Disabled: to disable override
		Non Snoop latency Override>	Manual: to manually enter override values and Auto (default): maintain default BIOS flow. [Disabled, Manual, Auto]
		Force LTR Override>	Force LTR override for PCH PCIe. Disabled: LTR override not forced Enable: LTR overrides values forced and LTR messages from device are ignored. [Enabled, Disabled]
		PCIe1 LTR Lock>	PCIe LTR configuration lock [Enabled, Disabled]
PCIe CLKREQ Mapping Override>	PCIe CLKREQ Override for default platform mapping [Default, No CLKREQ, Custom number]		
Extra Options>	Detect Non-Compliance Device>	Detects non-compliance PCI express device. If enabled, It takes more time at post time. [Enabled, Disabled]	

Function	Second level Sub-Screen / Description																	
PCI Express Configuration> (continued)	Extra Options> (continued)	Prefetch Memory>	Prefetchable memory range for this root bridge [10]															
		Reserved Memory Alignment>	Reserved memory alignments Range:(0-31)bits [1]															
		Prefetchable Memory Alignment>	Prefetchable memory alignments Range:(0-31) bits [1]															
	<p>Additional Information PCI port</p> <p>The PCIe menu refers to the different PCIe lanes using their chipset based numbers. For every lane, the number used on the COMe connector is mentioned. Take care to select the PCIe lane you require as numbering varies strongly.</p> <p>The standard layout for PCIe consists of 8 PCIe x 1 lanes. Other layouts may be programmed by flashing a different descriptor to the Intel firmware on the BIOS SPI flash. Contact Kontron Support if you require a different PCIe layout with your project.</p> <p>The PCIe BIOS layout for COMe PCIe lanes consists of a default BIOS built to fit most customer applications and offers two additional BIOS binaries for further common PCIe layouts.</p> <table border="1"> <thead> <tr> <th></th> <th>PCIe [0..3]</th> <th>PCIe [4..7]</th> <th>Name Extension</th> </tr> </thead> <tbody> <tr> <td>Default</td> <td>4x1</td> <td>4x1</td> <td>(8x1)</td> </tr> <tr> <td>Alternative 1</td> <td>1x4</td> <td>4x1</td> <td>1x4_4x1</td> </tr> <tr> <td>Alternative 2</td> <td>1x4</td> <td>1x4</td> <td>2x4</td> </tr> </tbody> </table> <p>Other layouts are available on customer request, contact Kontron Support if you require a different PCIe layout for your project.</p>				PCIe [0..3]	PCIe [4..7]	Name Extension	Default	4x1	4x1	(8x1)	Alternative 1	1x4	4x1	1x4_4x1	Alternative 2	1x4	1x4
	PCIe [0..3]	PCIe [4..7]	Name Extension															
Default	4x1	4x1	(8x1)															
Alternative 1	1x4	4x1	1x4_4x1															
Alternative 2	1x4	1x4	2x4															
SATA and RST Configuration>	SATA Controller>	SATA device [Enabled , Disabled]																
	SATA Mode Selection>	Determines SATA controllers operation [AHCI , Intel RST Premium]																
	SATA Test Mode>	Test mode enable/disable (loop back) [Enabled, Disabled]																
	Software Feature Mask Configuration>	HDD Unlock>	Enable indicates HDD password unlock in OS enabled. [Enabled , Disabled]															
		LED Locate>	Enable indicated that LED/SGPIO hardware is attached and ping to locate feature is enabled in OS. [Enabled , Disabled]															
	Aggressive LPM Support>	Enable PCH to aggressively enter link power state [Enabled, Disabled]																
	SATA Controller Speed>	Displays the maximum support supported by SATA controller [Default , Gen1, Gen2, Gen3]																
	Serial ATA Port 0 or Serial ATA Port 1 or Serial ATA Port 2 or	Software Preserve>	Read only field															
Port #>		SATA port # [Enabled , Disabled]																

Function	Second level Sub-Screen / Description		
SATA and RST Configuration> (continued)	Serial ATA Port 3 Serial ATA Port 0 or Serial ATA Port 1 or Serial ATA Port 2 or Serial ATA Port 3 (continued)	Hot Plug>	Designates port as Hot plug [Enabled, Disabled]
		Configured as eSATA>	Read only field
		Spin Up Device>	If enabled staggered spin-up is performed and only drives with this option enabled will spin up at boot. Otherwise all drives spin up at boot spin up device. [Enabled, Disabled]
		SATA Device Type>	Identifies if SATA port is connected to a solid-state drive or hard disk drive. [Hard Disk Drive , Solid State Drive]
		Topology>	Identify the SATA Topology [Unknown , ISATA, Direct Connect, FLEX, M2]
		SATA Port# DevSlp>	SATA Port# DevSlp [Enabled, Disabled]
		DITO Configuration>	DITO configuration [Enabled, Disabled]
		DITO Value>	Read only field [625]
		DM Value>	Read only field [15]
		USB Configuration>	XHCI Disable Compliance Mode>
xDCI Support>	xDCI (USB OTG device) [Enabled, Disabled]		
USB Port Disable Override>	Selectively enables or disables the corresponding USB port from reporting a device connection to the controller [Disabled , Select Per-Pin]		
Security Configuration>	RTC Lock>	Enable locks bytes 38h-3Fh in lower/upper 128 byte bank of RTC RAM [Enabled, Disabled]	
	BIOS Lock>	Enables or disables PCH BIOS lock enable feature. Required to be enabled to ensure SMM protection of flash. [Enabled , Disabled]	
HD Audio Configuration>	HD Audio>	Controls detection of the HD-Audio device Auto enables HD if present or disables if not present otherwise HD Audio is unconditionally enabled or disabled [Enabled, Disabled, Auto]	

Function	Second level Sub-Screen / Description		
HD Audio Configuration> (continued)	Audio DSP>	Enables or disables audio DSP [Enabled, Disabled]	
	HDA-Link Codec Select>	Selects the codec Platform on-board codec (single verb table) or External codec kit (multiple verb table) [Platform Onboard , External Kit]	
	iDisplay Audio Disconnect>	Disconnects SDI2 signal to hide/disable iDisplay audio codec [Enabled, Disabled]	
	PME Enable>	Enables PM wake of HD audio controller during post. [Enabled, Disabled]	
	HD Audio Advanced Configuration>	I/O Buffer Ownership>	Selects the ownership of the I/O buffer between Intel HD audio link and I2S port (for bilingual codecs). [HD-Audio Link , HD-Audio Link/I2S Port, I2S Port]
		I/O Buffer Voltage Select>	Selects the voltage operation mode of the I/O buffer [3.3 V , 1.8 V]
		HD Audio Link>	Selects HD audio link frequency Applicable only if HDA codec supports selected frequency. [6 MHz, 12 MHz, 24 MHz]
		iDisplay Link Frequency >	Selects iDisplay Link frequency. Applicable only if iDisp codec supports selected frequency. [48 MHz, 96 MHz]
PCH LAN Controller>	On-board NICs [Enabled , Disabled]		
Wake on LAN>	Integrated LAN to wake the system If ME is on in the Sx state, Wake On Lan cannot be disabled. [Enabled , Disabled]		
Serial IRQ Mode>	Configure serial IRQ mode [Quiet, Continuous]		
Port 61h Bit-4 Emulation>	Emulates Port 61h bit-4 toggling in SMM [Enabled , Disabled]		
State After G3>	Specifies state to go to when power is re-applied after power failure (G3 State). [S0 State , S5 State]		
Port 80h Redirection>	Controls where Port 80h cycles are sent [LPC Bus , PCIE Bus]		
Enhanced Port 80h LPC Decoding>	Supports word/dword decoding of port 80h behind LPC. [Enabled , Disabled]		

6.2.4. Security Setup Menu

The Security Setup menu provides information about the passwords and functions for specifying the security settings. The passwords are case-sensitive.

Figure 12: Security Setup Menu Initial Screen

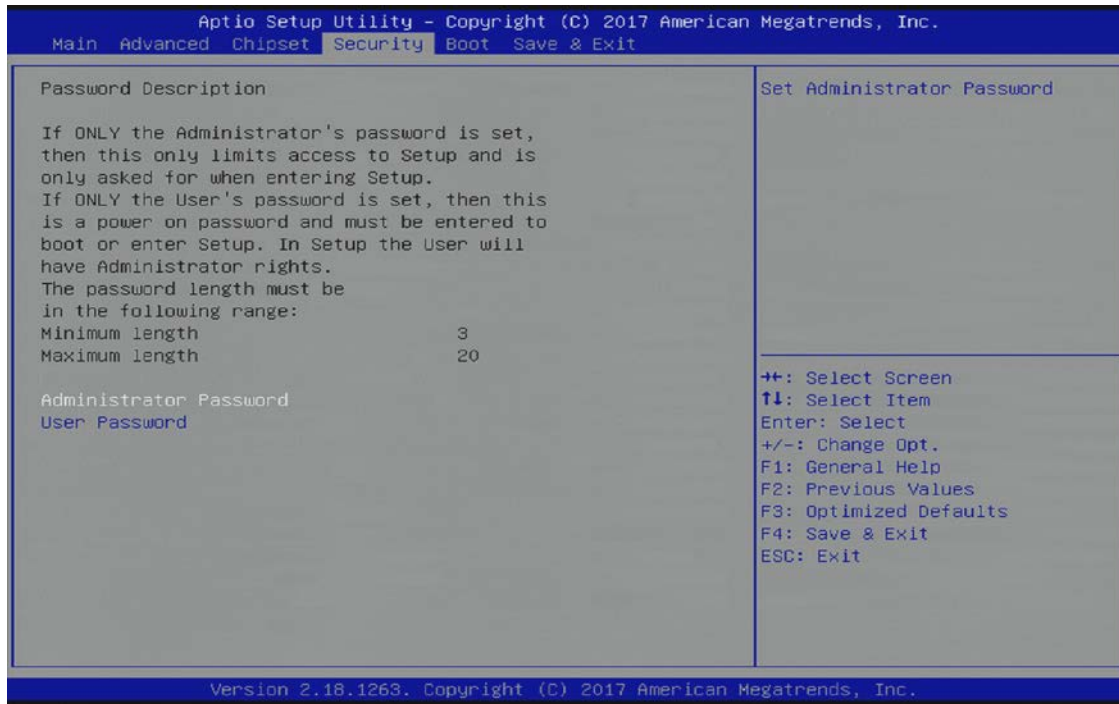

The following table shows Security sub-screens and functions.

Table 35: Security Setup Menu Functions

Function	Description
Administrator Password>	Set administrator password
User Password>	Set user password



If only the administrator's password is set, then only access to the setup is limited and is requested when entering the setup.

If only the user's password is set, then the password is a power on password and must be entered to boot or enter setup. In the setup the user has administrator rights.

The required password length in characters is max. 20 and min. 3.

6.2.4.1. Remember the Password

It is highly recommended to keep a record of all passwords in a safe place. Forgotten passwords results in the user being locked out of the system.

If the system cannot be booted because the User Password or the Supervisor Password are not known, clear the uEFI BIOS settings, or contact Kontron Support for further assistance.



HDD security passwords cannot be cleared using the above method.

6.2.5. Boot Setup Menu

The Boot Setup menu lists dynamically generated boot device priority order.

Figure 13: Boot Setup Menu Initial Screen

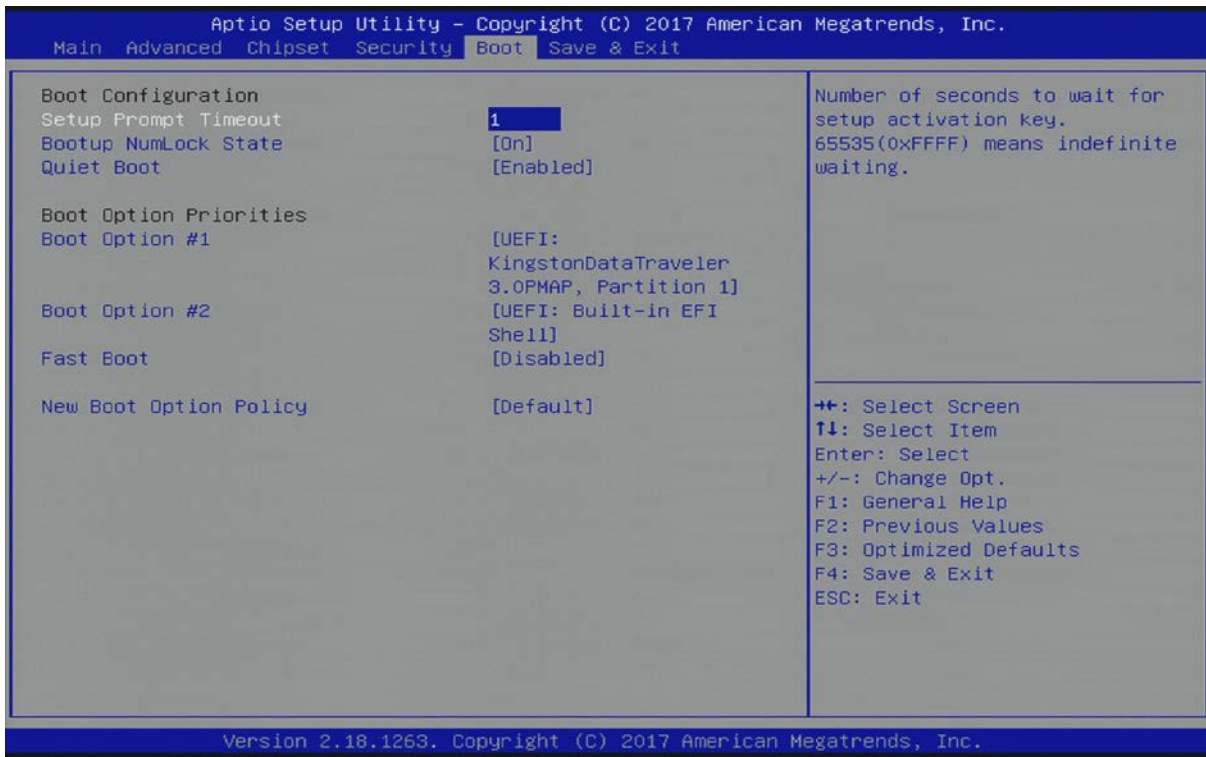

The following table shows Boot sub-screens and functions, and describes the content. Default settings are in **bold**.

Table 36: Boot Setup Menu Functions

Function	Description
Setup Prompt Timeout>	Displays number of seconds to wait for the setup activation key. 65535(OXFFF) means indefinite waiting
Bootup NumLock State>	Selects keyboard NumLock state [On, Off]
Quiet Boot>	Enables or disables Quiet Boot [Enabled, Disabled]
Boot Option #1>	Sets the system boot order (option 1) [UEFI kingstonDataTraveler 3.0PMAP partition 1 , UEFI Built-in EFI shell, Disabled]
Boot Option 2	Sets the system boot order (option 2) [UEFI kingstonDataTraveler 3.0 PMAP partition 1, UEFI Built-in EFI shell , Disabled]

Function	Description
Fast Boot>	Enables or disables boot with initialization of a minimal set of devices required to launch active boot option. This has no effect for BBS boot options. [Enabled, Disabled]
New Boot Option Policy>	Controls placement of newly detected UEFI boot options [Default, Place First, Place Last]

6.2.6. Save and Exit Setup Menu

The Save and Exit Setup menu provides functions for handling changes made to the uEFI BIOS settings and exiting the Setup program.

Figure 14: Save and Exit Setup Menu Initial Screen

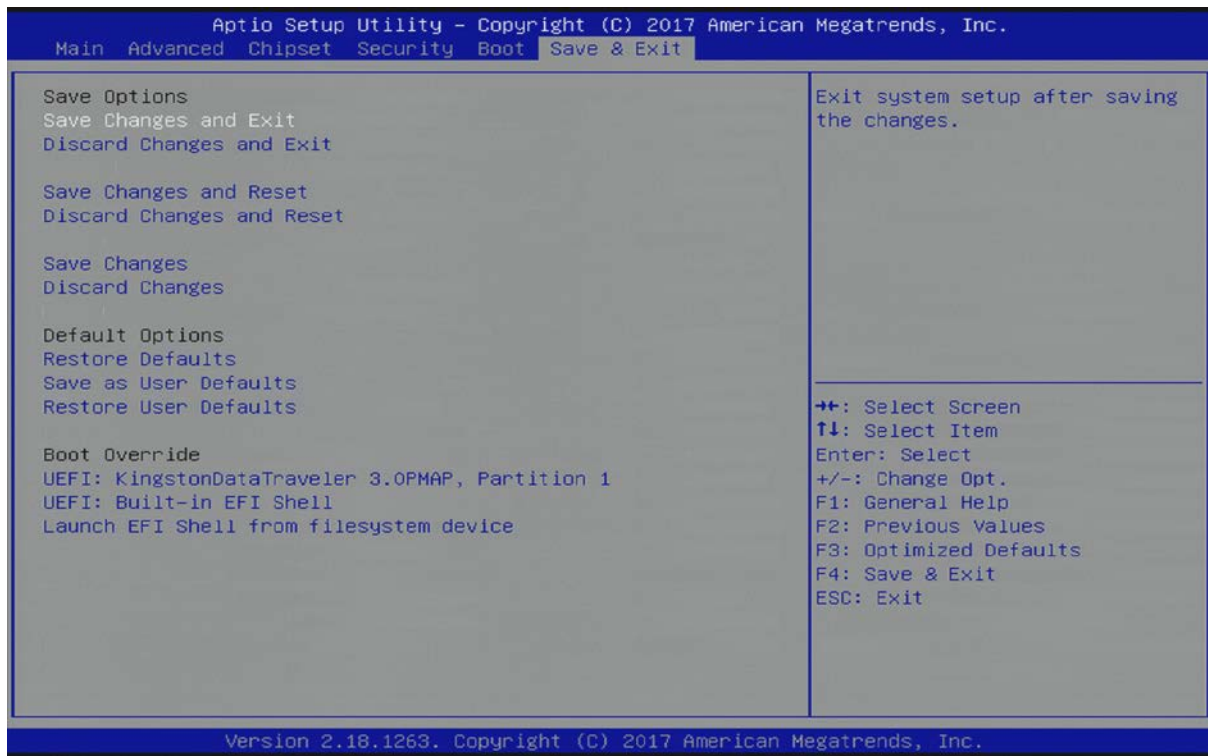

The following table shows Save & Exit sub-screens and functions, and describes the content.

Table 37: Save and Exit Setup Menu Functions

Function	Description
Save Changes and Exit>	Exits system after saving changes
Discard Changes and Exit>	Exits system setup without saving changes
Save Changes and Reset>	Reset system after saving changes
Discard Changes and Reset>	Resets system setup without saving changes
Save Changes>	Saves changes made so far for any setup options
Discard Changes>	Discards changes made so far for any setup options

Function	Description
Restore Defaults>	Restores/loads standard default values for all setup options
Save as User Defaults>	Saves changes made so far as user defaults
Restore User Defaults>	Restores user defaults to all setup options
UEFI Built-in EFI shell>	Attempts to launch the built in EFI Shell
Launch EFI Shell from File System Device>	Attempts to launch EFI Shell application (Shell.efi) from one of the available file system devices

6.3. The uEFI Shell

The Kontron uEFI BIOS features a built-in and enhanced version of the uEFI Shell. For a detailed description of the available standard shell scripting, refer to the EFI Shell User Guide. For a detailed description of the available standard shell commands, refer to the EFI Shell Command Manual. Both documents can be downloaded from the EFI and Framework Open Source Community homepage (<http://sourceforge.net/projects/efi-shell/files/documents/>).



AMI APTIO update utilities for DOS, EFI Shell and Windows are available at AMI.com:
<http://www.ami.com/support/downloads/amiflash.zip>.



Kontron uEFI BIOS does not provide all shell commands described in the EFI Shell Command Manual.

6.3.1. Basic Operation of the uEFI Shell

The uEFI Shell forms an entry into the uEFI boot order and is the first boot option by default.

6.3.1.1. Entering the uEFI Shell

To enter the uEFI Shell, follow the steps below:

To enter the uEFI Shell, follow the steps below:

1. Power on the board.
2. Press the <F7> key (instead of) to display a choice of boot devices.
3. Choose 'UEFI: Built-in EFI shell'.

```
EFI Shell version 2.40 [5.11]
Current running mode 1.1.2
Device mapping table
Fs0      :HardDisk - Alias hd33b0b0b fs0
          Acpi(PNP0A03,0)/Pci(1D|7)/Usb(1, 0)/Usb(1, 0)/HD(Part1,Sig17731773)
```

Press the ESC key within 5 seconds to skip startup.nsh, and any other key to continue.

4. The output produced by the device-mapping table can vary depending on the board's configuration.
5. If the ESC key is pressed before the 5 second timeout elapses, the shell prompt is shown:

```
Shell>
```

6.3.1.2. Exiting the uEFI Shell

To exit the uEFI Shell, follow one of the steps below:

1. Use the **exit** uEFI Shell command to select the boot device, in the Boot menu, that the OS will boot from.
2. Reset the board using the **reset** uEFI Shell command.

6.4. uEFI Shell Scripting

6.4.1. Startup Scripting

If the ESC key is not pressed and the timeout has run out then the uEFI Shell tries to execute some startup scripts automatically. It searches for scripts and executes them in the following order:

1. Initially searches for Kontron flash-stored startup script.
2. If there is no Kontron flash-stored startup script present then the uEFI-specified **startup.nsh** script is used. This script must be located on the root of any of the attached FAT formatted disk drive.
3. If none of the startup scripts are present or the startup script terminates then the default boot order is continued.

6.4.2. Create a Startup Script

Startup scripts can be created using the uEFI Shell built-in editor `edit` or under any OS with a plain text editor of your choice. To create a startup shell script, simply save the script on the root of any FAT-formatted drive attached to the system. To copy the startup script to the flash, use the **kBootScript** uEFI Shell command.

In case there is no mass storage device attached, the startup script can be generated in a RAM disk and stored in the SPI boot flash using the **kRamdisk** uEFI Shell command.

6.4.3. Examples of Startup Scripts

6.4.3.1. Execute Shell Script on other Harddrive

This example (**startup.nsh**) executes the shell script named **bootme.nsh** located in the root of the first detected disc drive (**fs0**).

```
fs0:  
bootme.nsh
```

6.5. Firmware Update

Firmware updates are typically delivered as a ZIP archive containing only the firmware images. The content of the archive with the directory structure must be copied onto a data storage device with FAT partition.

6.5.1. Updating Procedure

BIOS can be updated with the Intel tool fpt.efi using the procedure below:

1. Copy these files to an USB stick.

- ▶ flash.nsh (if available)
- ▶ fpt.efi
- ▶ fparts.txt
- ▶ bkl6r<xxx>.bin (where xxx stands for the version #)

2. Start the system into setup (see Chapter 6.1 Starting the uEFI BIOS).

3. Check that the following entries are set to their default setting:

Advanced > PCH FW Configuration > Firmware update configuration > ME FW Image Re-Flash > Disabled

Advanced > PCH FW Configuration > Firmware update configuration > Local FW Update > Enabled

Then, change the setup option:

Chipset > PCH-IO Configuration > BIOS Security Configuration > BIOS Lock > Disabled

4. Save and Exit BIOS setup.

5. On the next start, boot into shell (see Chapter 6.3.1.1 Entering the uEFI Shell).

6. Change to the drive representing the USB stick.

```
fsx: (x = 0,1,2,etc. represents the USB stick)
```

Change to the directory where you copied the flash tool.

```
cd <your_directory>
```

7. Start flash.nsh (if available)

OR type

```
fpt -SAVEMAC -F bkl6r<xxx>.bin
```

8. Wait until flashing is successful and then power cycle the board.



Do not switch off the power during the flash process! Doing so leaves your module unrecoverable.



Changes under point 3 are only effective during the first boot after the changes were applied. If you fail to flash during the next boot then you might have to repeat steps 3.



Do not forget to apply -SAVEMAC. If SAVEMAC is not applied then your system will lose it's system MAC address. If the MAC address is accidentally deleted, contact Kontron Support.

Appendix A: List of Acronyms

Table 38: List of Acronyms

ACPI	Advanced Configuration Power Interface	HBR2	High Bitrate 2
API	Application Programming Interface	HDA	High Definition Audio (HD Audio)
Basic Module	COM Express® 125 x 95 Module form factor	HD/HDD	Hard Disk /Drive
BIOS	Basic Input Output System	HDMI	High Definition Multimedia Interface
BMC	Base Management Controller	HPM	PICMG Hardware Platform Management specification family
BSP	Board Support Package	IZC	Inter integrated Circuit Communications
BPP	Bit Per Pixel	IOL	IPMI-Over-LAN
CAN	Controller-area network	IOT	Internet of Things
Carrier Board	Application specific circuit board that accepts a COM Express® module	IPMI	Intelligent Platform Management Interface
COM	Computer-on-Module	KCS	Keyboard Controller Style
Compact Module	COM Express® 95x95 Module form factor	KVM	Keyboard Video Mouse
CNTG	Computer Network Transaction Group	LAN	Local Area Network
DDC	Display Data Control	LPC	Low Pin-Count Interface:
DDI	Digital Display Interface –	LVDS	Low Voltage Differential Signaling –
DIMM	Dual In-line Memory Module	M.A.R.S.	Mobile Application for Rechargeable Systems
Display Port	DisplayPort (digital display interface standard)	MDI	Media Dependent Interface
DMA	Direct Memory Access	MEI	Management Engine Interface
DRAM	Dynamic Random Access Memory	Mini Module	COM Express® 84x55mm Module form factor
DVI	Digital Visual Interface	MTBF	Mean Time Before Failure
EAPI	Embedded Application Programming Interface	NA	Not Available
ECC	Error Checking and Correction	NC	Not Connected
EEPROM	Electrically Erasable Programmable Read-Only Memory	NCSI	Network Communications Services Interface
eDP	Embedded Display Port	PATA	Parallel AT Attachment
EMC	Electromagnetic Compatibility (EMC)	PCI	Peripheral Component Interface
ESD	Electro Sensitive Device	PCIe	PCI-Express
Extended Module	COM Express® 155mm x 110mm Module form factor.	PCN	Product Change Notification
FIFO	First In First Out	PECI	Platform Environment Control Interface
FRU	Field Replaceable Unit	PEG	PCI Express Graphics
Gb	Gigabit	PICMG®	PCI Industrial Computer Manufacturers Group
GBE	Gigabit Ethernet	PHY	Ethernet controller physical layer device
GPI	General Purpose Input	Pin-out Type	COM Express® definitions for signals on COM Express® Module connector pins.
GPIO	General Purpose Input Output	PS2	Personal System 2 (keyboard & mouse)
GPO	General Purpose Output	PSU	Power Supply Unit
GPU	Graphics Processing Unit	RoHS	Restriction of Hazardous Substances

RTC	Real Time Clock
SAS	Serial Attached SCSI – high speed serial version of SCSI
SATA	Serial AT Attachment:
SCSI	Small Computer System Interface
SEL	System Event Log
ShMC	Shelf Management Controller
SMBus	System Management Bus
SO-DIMM	Small Outline Dual in-line Memory Module
SOIC	Small Outline Integrated Circuit
SOL	Serial Over LAN
SPI	Serial Peripheral Interface

SSH	Secure Shell
TPM	Trusted Platform Module
UART	Universal Asynchronous Receiver Transmitter
UEFI	Unified Extensible Firmware Interface
UHD	Ultra High Definition
ULP	Ultra Low Power
USB	Universal Serial Bus
VGA	Video Graphics Adapter
VLP	Very Low Profile
WDT	Watch Dog Timer
WEEE	Waste Electrical and Electronic Equipment (directive)



About Kontron – Member of the S&T Group

Kontron is a global leader in IoT/Embedded Computing Technology (ECT). As part of the S&T technology group, Kontron offers individual solutions in the areas of Internet of Things (IoT) and Industry 4.0 through a combined portfolio of hardware, software and services. With its standard and customized products based on highly reliable state-of-the-art technologies, Kontron provides secure and innovative applications for a wide variety of industries. As a result, customers benefit from accelerated time-to-market, lower total cost of ownership, extended product lifecycles and the best fully integrated applications.

For more information, please visit: www.kontron.com



GLOBAL HEADQUARTERS

Kontron Europe GmbH
Gutenbergstraße 2
85737 Ismaning
Germany
Tel.: +49 821 4086-0
Fax: +49 821 4086-111
info@kontron.com